



# Host Nation Support Guidelines

For Foreign Assistance to Pakistan  
During Disasters

Government of Pakistan  
Prime Minister's Office  
National Disaster Management Authority



## **National Disaster Management Authority (NDMA)**

The National Disaster Management Authority (NDMA) was established in 2007 under the National Disaster Management Ordinance which was later passed as an Act of Parliament in 2010. NDMA is mandated with policy formulation and coordination of disaster management operations throughout the country at federal level.

## **Asian Disaster Preparedness Center (ADPC)**

For over 30 years, Asian Disaster Preparedness Center (ADPC) has been contributing in making Asia-Pacific safer by strengthening disaster resilience at all levels. Established in 1986, ADPC is as an independent regional organization. It works in a number of countries in the Asia region including Afghanistan, Bangladesh, Bhutan, Cambodia, China, India, Indonesia, Lao PDR, Maldives, Mongolia, Myanmar, Nepal, Pakistan, Saudi-Arabia, Sri Lanka, Thailand, the Philippines, and Vietnam. With headquarters located in Bangkok, Thailand, ADPC has country offices in Bangladesh and Myanmar. ADPC's well-established networks with government line agencies and strong partnerships with regional organizations and development agencies provide the foundation for its work.

## **Australian High Commission**

The Australian High Commission represents the Australian Government in Pakistan, promoting stronger relations with Pakistan. Australia established diplomatic relations with Pakistan in 1947 and has had a resident mission in the country since 1948. Australia and Pakistan enjoy a common heritage and shared interests, including a passion for sports and the arts. Our strong people to people links centre on an active and successful Pakistani community in Australia. Australia has strong interests in Pakistan given its size, economic potential and strategic position in the Indo-Pacific region, and is committed to supporting Pakistan to build its economic prosperity, and promote sustainable, equitable development in line with Pakistan's development policy, Vision 2025.

This publication has been funded by the Australian Government through the Department of Foreign Affairs and Trade. The views expressed in this publication are the author's alone and are not necessarily the views of the Australian Government.

### **NDMA Contact**

Director (Response)

Tel: +92 51 9205035

Email: [dirresponse@ndma.gov.pk](mailto:dirresponse@ndma.gov.pk)

### **Authors/Project Team**

Ms Jennifer McKay

Lieutenant General Asif Yasin Malik HI(M) (Rtd)

Mr Irfan Maqbool

Mr John Abo

Brigadier Ishaq Ahmed (Rtd)

Ms Maha Mussadaq

Lieutenant Colonel Masood Qureshi (Rtd)

## Acknowledgements

The thoughts and experiences of the many organisations and individuals who contributed to the development of the Host Nation Support Guidelines including the Secretary of Foreign Affairs, Secretary of Ministry of Interior, Economic Affairs Division, Customs Wing of the Federal Board of Revenue, Ministry of Information, Broadcasting & National Heritage, Ministry of National Health Services, Regulation and Coordination, National Health Emergency Preparedness Network, Pakistan Telecommunications Authority, Joint Services Headquarters, Military Operations Directorate at GHQ, Pakistan Navy, Pakistan Air Force, PDMAs, the UN Resident Coordinator, OCHA, FAO, and various UN agencies, Australian High Commission, Australian Civil-Military Centre, USAID, Pakistan Humanitarian Forum, Pakistan Poverty Alleviation Fund, Federation of Pakistan Chambers of Commerce & Industry, and others, are gratefully acknowledged.

The ADPC team is highly appreciative of the guidance and support of the Chairman, NDMA, Lieutenant General Omar Mahmood Hayat HI (M), and his team.



# Contents

Acknowledgements	3
Acronyms	8
Foreword	11
Executive Summary	13
Map of Pakistan	15

## Section 1 16

Introduction	16
Pakistan	16
About the Guidelines	18
Contribution to Regional Knowledge	18
Heart of Asia Disaster Management – Confidence Building Measures (HOA DM–CBM)	18
Methodology	19
Necessity for Guidelines	19
Natural Disasters	19
Phases of Disaster Management	20
Epidemics and Pandemics	21
Using the Guidelines	21
Challenges in Foreign Assistance in Response	21
Definitions	23

## Section 2 25

Host Nation Coordination	25
National Disaster Management Act 2010	25
Activities on Accepting Foreign Assistance.	25
National Disaster Management Authority (NDMA)	25
NDMA Coordination Meetings	27
Needs Assessments	27
Multi-Sector Initial Rapid Assessment (MIRA)	28
Timeline for MIRA Process	28
When Foreign Assistance is Required	29
Pakistan’s Hierarchical Response Strategy	30

## Section 3 31

Overarching Principles for Foreign Assistance	31
---	----

## Section 4 35

4.0 Guide for Government of Pakistan Stakeholders	35
Preparedness	35
When the Disaster Strikes	35
Monitor, Assess and Implement	36
Communicate	36
Respond to Offers of Assistance	37
Receive	37
Manage	37
Terminate Response	38

<b>Section 5</b>	<b>39</b>
<b>Government Key Stakeholders</b>	<b>39</b>
Key Government Ministries and Departments	39
Ministry of Finance – Economic Affairs Division (EAD)	39
Ministry of Foreign Affairs (MoFA)	39
Ministry of Interior	40
Visas	40
INGOs – Special Policies	40
No Objection Certifications (NOCs) and Security Procedures	41
Federal Board of Revenue (FBR) – Customs Wing	41
Ministry of Maritime Affairs	41
Pakistan International Airlines (PIA)	41
Pakistan Meteorological Department (PMD)	41
Ministry of Information Technology and Telecom (MOIT)	42
Pakistan Telecommunications Authority (PTA)	42
Approval for Import and Use of ICT Equipment for Disaster Management	42
Procedure for Encryption / Inbuilt Ciphering Devices Certification	43
Requirements for Evaluation of Equipment Using Cypher and Coding Protocols.	43
Prevention of Electronic Crimes Act 2016	43
Ministry of Information, Broadcasting, and National Heritage	44
Press Information Department (PID)	44
Cyber Wing	44
External Publicity Wing	44
National Disaster Management Authority (NDMA) – Media Cell	45
Inter-Services Public Relations (ISPR) – Pakistan Military	45
Pakistan Electronic Media Regulatory Authority (PEMRA) – Laws on Disaster Reporting	45
Ministry of National Health Services, Regulation and Coordination	45
National Health Emergency Preparedness Network (NHEPRN)	46
Ministry of Food Security and Research – Animal Quarantine Department (AQD)	46
Survey of Pakistan - Mapping	46
Funding Appeals	46
Provincial Disaster Management Authorities	46
Provincial Emergency Services	48
Rescue 1122	49
<b>Section 6</b>	<b>50</b>
<b>Military</b>	<b>50</b>
Pakistan Armed Forces	50
Foreign Militaries	50
Joint Aviation Coordination Cell (JACC)	51
Pakistan Air Force - Air Headquarters, Islamabad	51
Organisation of Joint Air Coordination Cell (JACC)	52
UN and Humanitarian Organisations	53
Civil-Military Coordination with Humanitarian Community (CMCoord)	53
<b>Section 7</b>	<b>54</b>
<b>Guide for Assisting Countries &amp; Humanitarian Community</b>	<b>54</b>
Prepare/Get Ready	54
Special Policies – INGOs	54
Initiate	54
Responding to Needs	54
Country Entry Requirements	54

Arrival	55
Coordination	56
Cluster Management	56
Exit and Handing Over	56
<b>Section 8</b>	<b>57</b>
<b>Guidance for Foreign Responders</b>	<b>58</b>
Assisting Countries	58
Integrated/Multi-Agency Missions	58
Case Study: Australian Medical Task Force – Pakistan 2010 Floods	58
Humanitarian Community	59
UNITED NATIONS	61
UN RESIDENT COORDINATOR (UNRC)	61
UNOCHA	61
United Nations Disaster Assessment and Coordination (UNDAC)	61
Inter Agency Standing Committee (IASC)	62
International Search and Rescue Advisory Group (INSARAG)	62
On-Site Operations Coordination Centre (OSOCC)	63
Cluster System	63
International Red Cross and Red Crescent Movement	64
International Committee of the Red Cross and Red Crescent (ICRC)	65
The Pakistan Red Crescent Society (PRCS)	65
International and National Non-Government Organisations (INGOs and NGOs)	66
INGO Policy and Rules	66
Pakistan Humanitarian Forum (PHF)	66
Pakistan Humanitarian Organisations and Networks	67
Edhi Foundation	67
Rural Support Programmes Network (RSPN)	67
Aga Khan Foundation	67
National Humanitarian Network (NHN)	67
Pakistan Poverty Alleviation Fund (PPAF)	68
Pakistan Centre for Philanthropy (PCP)	68
Private Sector	68
Federation of Pakistan Chambers of Commerce & Industry (FPCCI)	69
Philanthropists and Overseas Pakistanis	69
<b>Section 9</b>	<b>70</b>
<b>Health Response – Foreign Medical Teams</b>	<b>70</b>
Foreign Medical Teams (FMT)	70
CLASSIFICATION OF FMT	70
FMT Type 1: Outpatient Emergency Care	70
FMT Type 2: Inpatient Surgical Emergency Care	71
FMT Type 3: Inpatient Referral Care	72
Core Standards for Foreign Medical Teams	74
Entry of Foreign Field Hospitals (FFH)	74
Terminologies	76
<b>Section 10</b>	<b>79</b>
<b>Civil-Military Coordination (CMCoord)</b>	<b>79</b>
International Principles on Civil-Military Coordination	79
UN Humanitarian Civil-Military Coordination (UN CMCoord)	79
Civil-Military Guidelines: UNOCHA - Oslo Guidelines on the Use of Foreign Military and Civil	79
Defence Assets in Disaster Relief	80

<b>Section 11</b>	<b>81</b>
<b>Humanitarian Principles &amp; Minimum Standards</b>	<b>81</b>
Gender, Children, and Most Vulnerable (Ensuring consideration)	81
National Policy Guidelines of Vulnerable Groups in Disasters – NDMA Gender and Child Cell	81
Overarching National Policy Guidelines on Vulnerable Groups in Disasters	81
Gender	83
Children	83
Older Persons and Persons with Disabilities	84
International Humanitarian Standards	85
Core Humanitarian Standard	85
Sphere Handbook - Humanitarian Charter and Minimum Standards in Humanitarian Response	85
Do No Harm – Unintended Consequences	86
Principles and Rules for Red Cross and Red Crescent Humanitarian Response	86
Linking Response to Recovery	87
Time to Leave – Termination of Response	89
Handing Over	89
Reporting	89
Gifting of Equipment and Goods	89
Reporting	89
Gifting of Equipment and Goods	89

<b>Annex 1</b>	<b>90</b>
Role of Customs Wing in Facilitation of Disaster Response	91
<b>Annex 2</b>	<b>94</b>
Objectives and Services of PMD	94
<b>Useful References</b>	<b>96</b>
Pakistan	96
Regional Guidelines	96
ASEAN	96
Asia-Pacific Economic Cooperation (APEC) – Emergency Preparedness Working Group (EPWG)	96
East Asia Summit (EAS) – Eas Toolkit	96
United Nations Guidelines	96
Inter-Agency Standing Committee (IASC)	97
World Health Organisation (WHO)	97
Red Cross And Red Crescent Movement	98
Civil-Military Coordination	98
Humanitarian Principles	98
World Customs Organization (WCO)	99



# Acronyms

ACMC	Australian Civil-Military Centre
AKF	Aga Khan Foundation
AHA	ASEAN Coordinating Centre for Humanitarian Assistance on Disaster Management
APEC	Asia-Pacific Economic Cooperation
APP	Associated Press of Pakistan
CAP	Consolidated Appeals Process
CBOs	Community Based Organisations
CGO	Customs General Order
CHS	Core Humanitarian Standard
CPWG	Child Protection Working Group
CMCoord)	Civil-Military Coordination
DDMA	District Disaster Management Authority
DM	Disaster Management
DREF	Disaster Relief Emergency Fund
DRR	Disaster Risk Reduction
EAD	Economic Affairs Division
EAS	East Asia Summit
ERF	Emergency Response Framework
ERRA	Earthquake Reconstruction and Rehabilitation Authority
ESB	Emergency Service Branch
FACT	International Federation Field Assessment and Coordination Team
FAO	Food and Agriculture Organisations of the United Nations
FATA	Federally Administered Tribal Areas
FBR	Federal Board of Revenue
FCSS	Field Coordination Support Section
FDMA	FATA Disaster Management Authority
FMTs	Foreign Medical Teams
FPCCI	Federation of Pakistan Chambers of Commerce & Industry
GoP	Government of Pakistan
GLOF	Glacial Lake Outburst Floods
GBDMA	Gilgit Baltistan Disaster Management Authority
HCT	Humanitarian Country Team
HOA	Heart of Asia Istanbul Process
HOA DM-CBM	Heart of Asia Disaster Management- Confidence Building Measure
IASC	Inter Agency Standing Committee
ICT	Information and Communications Technology
ICRC	International Committee of the Red Cross and Red Crescent
INGOs	International Non-Government Organisations
INSARAG	International Search and Rescue Advisory Group
IOM	International Organisation for Migration
ISPR	Inter-Service Public Relations
JACC	Joint Aviation Coordination Cell
LEMA	Local Emergency Management Authority
MO Dte	Military Operations Directorate
MoFA	Ministry of Foreign Affairs
MoI	Ministry of Interior
MoIT	Ministry of Information Technology and Telecom
NDMA	National Disaster Management Authority
NDMC	National Disaster Management Commission
NEOC	National Emergency Operations Centre
NGO	Non-Governmental Organisation
NHEPRN	National Health Emergency Preparedness Network
NHN	National Humanitarian Network
NIDM	The National Institute of Disaster Management

NOC	No Objection Certificate
ODRP	Office of the Defence Representative
OHCHR	The Office of the United Nations High Commissioner for Human Rights
OPS	Operations Wing of NDMA
OSOCC	On-Site Operations Coordination Centre
PAF	Pakistan Air Force
PCT	Pakistan Customs Tariff
PDMA	Provincial Disaster Management Authority
PEMRA	Pakistan Electronic Media Regulatory Authority
PHF	Pakistan Humanitarian Forum
PID	Press Information Department
PMD	Pakistan Meteorological Department
PPAF	Pakistan Poverty Alleviation Fund
PRCS	Pakistan Red Crescent Society
PTA	Pakistan Telecommunications Authority
PTV	Pakistan Television
RSPN	Rural Support Programmes Network
SOPs	Standard Operating Procedures
UN	United Nations
UNDAC	United Nations Disaster Assessment and Coordination
UNDP	United Nations Development Programme
UNFPA	United Nations Population Fund
UN-HABITAT	United Nations Human Settlements Programme
UNHAS	United Nations Humanitarian Air Service
UNHC	United Nations Humanitarian Coordinator
UNHCR	United Nations High Commissioner for Refugees
UNICEF	United Nations Children's Fund
UNISDR	United Nations Office for Disaster Risk Reduction
UNOCHA	United Nations Office for the Coordination of Humanitarian Affairs
UNRC	United Nations Resident Coordinator
UNWOMEN	United Nations Entity for Gender Equality and the Empowerment of Women
USAR	Urban Search and Rescue
WASH	Water and Sanitation
WCO	World Customs Organisation
WFP	World Food Programme
WHO	World Health Organisation

## Foreword

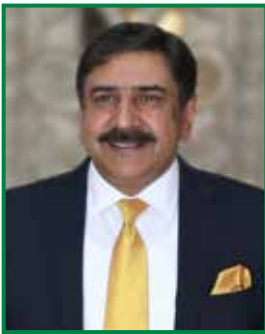

Experiences of two of the largest disasters in Pakistan in recent years – the 2005 Kashmir Earthquake and the 2010 Super Floods – have highlighted the need for enhanced understanding of the complexities of massive logistics and coordination efforts required including those for managing foreign assistance should local capacities become overwhelmed.

Pakistan has since developed substantial national and provincial capacities and is able to respond to the many types of potential disasters that can occur. However, the scale of a catastrophic event can overwhelm national capacities in any country. At such times, it may become necessary to request foreign assistance. Foreign assistance is of great value, but it also increases the level of coordination for the host country and the need for understanding the local context by the foreign responders. The *Host Nation Support Guidelines* will ensure a clear understanding of the rules, responsibilities and processes for all stakeholders.

The need for guidelines for managing foreign assistance and integrating it into the national response in future large-scale disasters, was identified in NDMA’s “Learning from Experience – Pakistan 2010 Floods”. With the support of the Australian High Commission in Islamabad, ADPC, and a team of locally-based specialist consultants working in coordination with NDMA, the *Host Nation Support Guidelines for Pakistan* were developed after extensive consultations with a wide range of stakeholders, and extensive research on national and international guidelines for disaster response, and lessons learned from various large-scale disasters in Asia.

Large-scale disasters bring together a diverse group of civil and military stakeholders. Coordination between the civilian (government agencies, UN agencies, I/NGOs and other humanitarian actors), and military responders is one of the key challenges of large-scale disaster response. Ensuring a common operating picture is vital to avoid delays and duplication of effort. NDMA takes the lead role in coordinating between both the civilian responders and the military to ensure understanding of the parameters, to avoid duplication, and to affect a seamless response.

The *Host Nation Support Guidelines for Pakistan* also contributes to regional disaster management knowledge and understanding between Heart of Asia countries of each country’s national processes for response. This is particularly important in the instance of be trans-border catastrophes. NDMA, on behalf of the Government of Pakistan has *Co-Chaired the Heart of Asia: Disaster Management – Confidence Building Measures* initiative of the Heart of Asia Istanbul Initiative, since its inception and works with countries in the region to exchange knowledge, experience, and assistance.

The generous goodwill gestures of assistance from foreign countries in past disasters has been greatly appreciated and provided humanitarian support to millions of Pakistanis. NDMA will continue to work with all stakeholders to build the capacity needed to ensure best utilisation of relief assistance provided by foreign countries and from within Pakistan to mitigate the impacts of disasters. I congratulate all contributors to this important process and thank them for their valuable support

**Lieutenant General Omar Mahmood Hayat, HI(M)**  
Chairman  
National Disaster Management Authority (NDMA)



# Executive Summary

The *Host Nation Support Guidelines* for Pakistan focuses on information and actions to reduce response time in large-scale disasters that may require foreign assistance should local capacity be overwhelmed. The Guidelines are designed to identify the mandates, roles and responsibilities, processes, clearance requirements, and coordination procedures to provide a common operating picture for all decision-makers in Government, the Armed Forces, Assisting Countries and International Humanitarian Organisations.

The Guidelines focus only on the complex matter of receiving and managing foreign assistance in large-scale disasters, primarily at **National level**. They support the overall national response and further development of NDMA's preparedness and response framework and training activities.

Requesting international assistance, including accepting deployment of assets, equipment and personnel in addition to funds, is a major decision for any government to take when faced by a massive disaster. It is both preferable and reasonable for any country to take all steps to first respond to the situation internally. However, delays can cost lives and create unnecessary hardship for affected communities. When local capacity is overwhelmed, foreign assistance may be requested from friendly countries and accepted after a systematic evaluation and clearances from relevant stakeholders. While foreign assistance can bring additional resources and assets, it also requires a higher degree of coordination to manage and integrate with local stakeholders for optimal impact so should be kept to a minimum. Therefore, clarity on when to take this step and how to manage it is critical.

Foreign assistance brings together a complex array of inter and intra-government and civil-military cooperation: the need for a common operating picture of what is required for all components of accepting assistance; experienced disaster management officers in key agencies; logistics; security; and of various guidelines and internal standard operating procedures (SOPs) for stakeholders.

To further enhance knowledge on the processes involved, the Host Nation Support Guidelines were developed in collaboration between NDMA and a project team of the Asian Disaster Preparedness Center, with the support of the Australian High Commission, Islamabad. An extensive literature review was conducted on national and international guidelines, and consultations were held with key stakeholders from Government, Pakistan Armed Forces, UN and the humanitarian community, and the private sector.

The Guidelines are divided into eleven sections and annexes to provide guidance for all groups of stakeholders relevant to their role and the operating environment.

Section 1	–	Introduction
Section 2	–	Host Nation Coordination
Section 3	–	Overarching Principles for Foreign Assistance
Section 4	–	Guide for Government of Pakistan Stakeholders
Section 5	–	Government Key Stakeholders
Section 6	–	Military
Section 7	–	Guide for Assisting Countries and Humanitarian Community
Section 8	–	Guidance for Foreign Responders
Section 9	–	Health Response
Section 10	–	Civil-Military Coordination (CMCOORD)
Section 11	–	Humanitarian Principles and Minimum Standards
Annexes and Useful References		

# Map of Pakistan

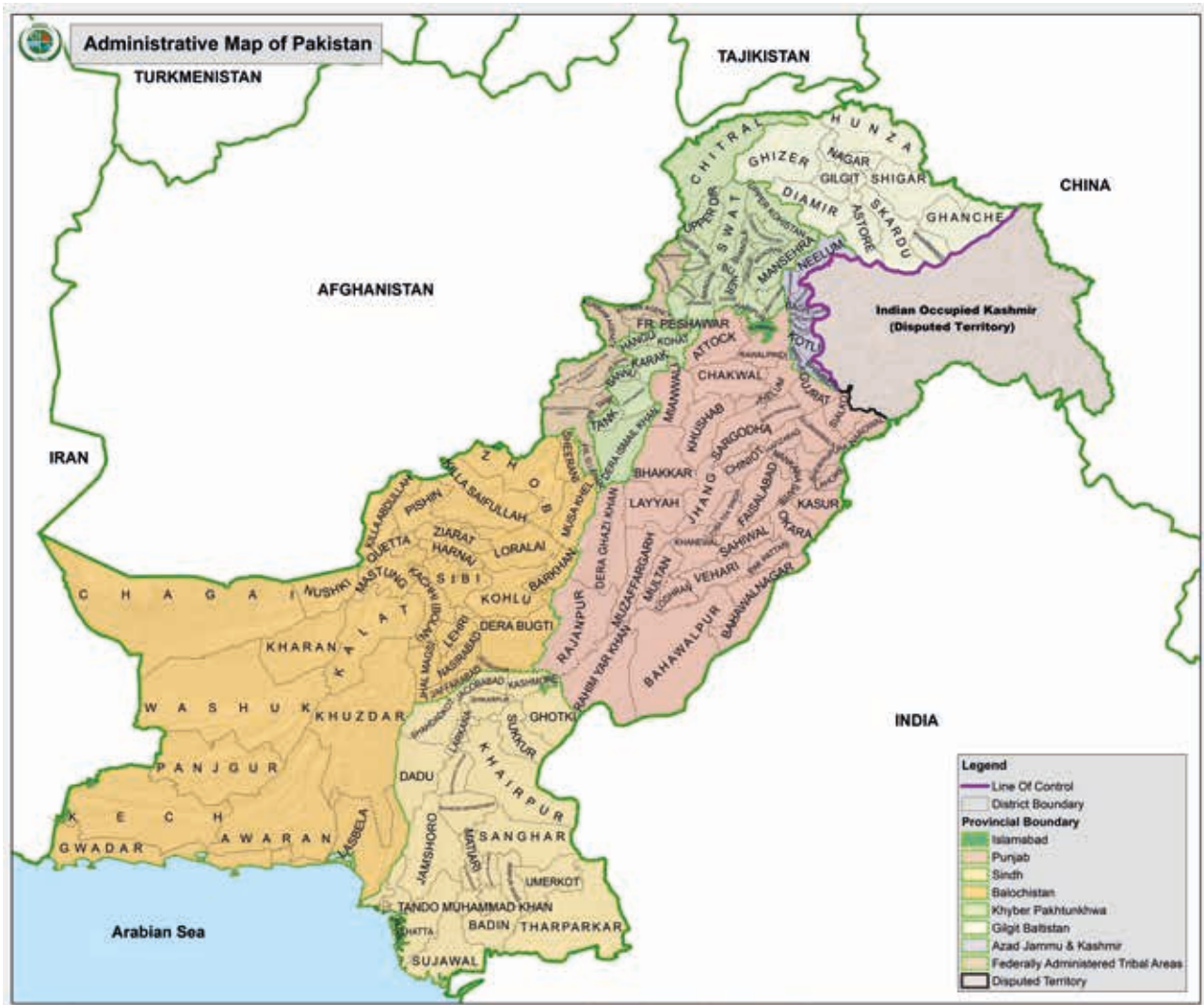

## Section

# 1

## Introduction

### Pakistan

Pakistan has a population of approximately 213.36 million<sup>1</sup> people including all regions / states. The country is diverse in geography and cultures. Rising from the coastal areas of Sindh and Balochistan on the Indian Ocean, across deserts and plains, to the high mountains of the Himalayas, Karakoram, and Hindu Kush, some which reach over 8,000 metres. The country is bordered by Iran, Afghanistan, China, and India, with a coastline of over 1,000 kilometres on the Arabian Sea.

In recent years Pakistan has been struck by a number of massive disasters. In 2005 an earthquake in northern Pakistan killed 73,000 people, injured 120,000 and displaced 3.5 million people. In 2010, massive floods devastated one fifth of Pakistan, affecting almost 20 million people. The floods, initially triggered by cloudbursts delivering one year's worth of rains in 36 hours, set off a chain of weather events that eventually flooded one fifth of the country. Floods continue to be a frequent event with severe emergencies from 2011- 2014 affecting millions of people.

In July 2015, Chitral was struck by flash floods and in October, an earthquake centred across the border in northern Afghanistan, devastated the same region of Chitral and other parts of Khyber Pakhtunkhwa, leaving 232 dead and causing substantial damage. Chitral was again struck by flash floods in July 2016 with the loss of another 41 lives. In the south and south-west, at least six cyclones have struck the coastal areas since 2001 and Balochistan was struck by earthquakes in 2008 and again in 2013.

Pakistan is in the top ten countries affected by Climate Change. According to the Ministry of Climate Change (MoCC); Climate Change is causing increased variability in the monsoon patterns; glacier recession of the Hindukush-Karakorum-Himalaya Glaciers which threaten Indus River flows; increased risk of extreme events (floods; droughts; cyclones; extreme high/low temperatures; severe water and heat-stressed conditions in arid and semi-arid regions impacting on agricultural productivity; timing of weather changes impacting on crop patterns; decrease in forest cover; loss of bio-diversity; increased salinity in the Indus Delta due to rising sea levels; damage to mangroves and fish breeding grounds; and health risks.

In early half of the twentieth century, this region has suffered other large-scale disasters that have been all but forgotten including the 1935 Quetta earthquake, which had a death toll with estimates ranging between 30,000 and 60,000 people. In 1945 the Makran Tsunami, triggered by an undersea earthquake in the Makran Subduction Zone, struck the coastlines of Balochistan and Sindh, and more than 5,000

---

<sup>1</sup> Pakistan Bureau of Statistics. Pakistan Preliminary Census . 2017

people lost their lives. The seismic risk in these two areas remains dangerous. A catastrophe in this coastal region could cause great devastation, even in cities like Karachi, a financial and industrial hub of the country, where natural, industrial and technical disasters would be particularly devastating. Evacuation of Karachi would be all but impossible in the time available to reach safety.

In past disasters in Pakistan, particularly in the massive 2010 super floods, significant problems slowed the flow of international relief. This included problems in receiving and distributing goods that arrived by air and sea, customs clearances, and inappropriate and unsolicited relief goods. In addition, coordination problems were identified between the UN and the Government, crossing of 'red lines' by humanitarian agencies in areas controlled and coordinated by the military, and an uneven deployment of assistance. These problems created unnecessary delays, exclusion, and further suffering for affected communities in some areas.

Although other natural disasters have occurred since the 2010 Super Floods, none have required that massive level of international assistance. More recent events have required monetary and capacity support. Given Pakistan's high risk of large-scale disasters, it is important that the documentation and preparation for any future catastrophic event, include guidelines for requesting, receiving and managing foreign assistance should the country be overwhelmed by the magnitude of the crisis beyond its own coping capacities.

Long periods of displacement from both natural disasters and emergencies, and the loss of livelihood, crops, and livestock, places enormous strain on communities and on the national economy. A high proportion of the displaced in emergencies have been women. They are the most affected primarily due to cultural norms. Although there have been significant steps forward in addressing gender and child needs, and those of the most vulnerable members of society, more needs to be done to ensure their needs are addressed from the onset of an emergency, be it natural calamity or complex emergency. All response and relief assistance must be considered from a gender and most vulnerable perspective.

With frequent disasters, high levels of poverty, and a burgeoning population with poor water and sanitation conditions, epidemics and pandemics remain a risk in Pakistan at all times. These risks must be addressed in disaster risk management planning. In natural disasters the risks are exacerbated making a rapid and effective health response by both national authorities and, when necessary, from foreign medical teams, is paramount. The *Host Nation Support Guidelines* provide useful information both for decisions-makers in Pakistan and for responding countries and organisations.

The ultimate beneficiaries are the people of Pakistan who may be affected by future emergencies. Effective and rapid response reduces the possibility of disruption to current Government and donor investments in the development sector and contributes to future stability and prosperity in both the country and the region.

Being prepared, and understanding the complexities of the situation and managing foreign assistance when required, will contribute greatly to a more rapid and effective response.

## About the Guidelines

The *Host Nation Support Guidelines* for Pakistan focuses on actions to reduce the response time through a set of clearly defined Guidelines for decision-makers in Government, Assisting Countries and International Humanitarian Organisations. The Guidelines are designed to identify the mandates, roles and responsibilities, processes, clearance requirements, and coordination procedures to provide a common operating picture for all stakeholders.



Requesting international assistance, including accepting deployment of assets, equipment and personnel in addition to funds, is a major decision for any government to take when faced by a massive disaster. It is both preferable and reasonable for any country to take all steps to first respond to the situation internally. However, delays can cost lives and create unnecessary hardship for affected communities.

**The Guidelines focus only on the complex matter of receiving and managing foreign assistance in large-scale disasters, primarily at the national level. It contributes to and supports the national response.**

When local capacity is overwhelmed, foreign assistance may be requested from friendly countries and accepted only after a systematic evaluation and clearances from relevant stakeholders. While foreign assistance can bring additional resources and assets, it also requires a higher degree of coordination to manage and integrate with local stakeholders for optimal impact so should be kept to a minimum. Clarity on when to take this step and how to manage it is critical.

Foreign assistance brings together a complex array of inter / intra-government and civil-military cooperation, the need for a common operating picture of what is required for all components of accepting assistance, experienced disaster management officers in key agencies, logistics, processes, security, and of various guidelines and internal standard operating procedures (SOPs) for stakeholders.

## Contribution to Regional Knowledge

### *Heart of Asia Disaster Management – Confidence Building Measures (HOA DM–CBM)*

The Guidelines also contribute to regional initiatives and understanding between Participating Countries in the Disaster Management – Confidence Building Measures (DM-CBM) of Heart of Asia Istanbul Process, to recognise the need to build and enhance cooperation in the region through neutral entry points. Heart of Asia is a regional initiative focused on a secure, stable and prosperous Afghanistan in a secure and stable region by promoting regional security and cooperation through measures to build confidence and trust among countries.

A number of Confidence-Building Measures (CBMs) were agreed between Participating and Supporting Countries to facilitate the Process and to enhance stability in the region. ‘Development of joint guidelines for cooperation in the field of disaster management (Disaster Management CBM)’ is one of the key priorities. Pakistan and Kazakhstan co-chair this initiative.

To facilitate the development of regional guidelines, each Participating Country must first develop their own Host Country Support Guidelines. However, few, if any of the countries currently have specific guidelines to manage foreign assistance although most have national disaster response plans.

Pakistan is addressing its contribution to regional understanding of the challenges in managing disasters in Heart of Asia and other countries, through the development of the *Host Nation Support Guidelines* for Pakistan to ensure a clear understanding of the rules, responsibilities and processes within Pakistan related to receiving foreign assistance.

## Methodology

The process of developing the *Host Nation Support Guidelines* included an extensive literature review of international, national and regional guidelines for foreign assistance in response, existing/available SOPs, international humanitarian principles, and lessons learned from previous mega-disasters in Pakistan and other countries. In addition, consultations were conducted with key stakeholders from

Government Ministries, Departments Organisations, the Pakistan Armed Forces, United Nations (UN) agencies, humanitarian organisations, foreign missions and donors, and the private sector.

## Necessity for Guidelines

### Natural Disasters

For all countries, making the decision to accept foreign assistance is a sensitive and difficult matter. One of the key decisions is at what point should foreign assistance be requested. Most countries prefer as their first choice, to handle the emergency using internal resources. However, in large-scale disasters like earthquakes, national capacity can quickly become overwhelmed by the scale of the event.

These guidelines will assist Government decision-makers identify the escalation points where local capacity is most likely to be overwhelmed, the type of assistance that may be required, and the protocols. This will contribute to a more systematic approach as to when and where the international community can respectfully engage to ensure timely action and, ultimately, a reduction in lives lost.

The guidelines consider the roles and responsibilities of Government decision-makers and how to effectively receive and utilise all forms of foreign and cross-border assistance. Foreign assistance may include relief goods, medicines, deployment of civilian / military personnel, assets (such as helicopters) and field hospitals. Such guidelines/SOPs were called for in the NDMA Lessons Learned from the 2010 Pakistan Floods<sup>2</sup>. The *Host Nation Support Guidelines* provide timely actions needed to ensure that the delays and challenges encountered in other disasters do not recur.

Lessons from foreign assistance from previous disasters in Pakistan and across Asia have identified best practices including examples of how assisting countries can provide a ‘whole-of-government’ or multi-agency response team and coordinate with the Host Nation. Countries like Australia and the United States have previously used this model in disaster assistance to Pakistan. This can make the coordination processes smoother for the Host Country.

Disaster Management capabilities in Pakistan have grown and improved considerably since 2010 and the country is able to manage many types of disasters without the need for foreign assistance. This can be attributed to investments in Disaster Risk Reduction, Community Based Disaster Risk Management, capacity building, contingency planning, greater awareness, early warnings, and also an overwhelming societal response.

With the support of various donors, National Disaster Management Authority (NDMA) has developed the National Disaster Management Plan 2012, and an extensive portfolio of Guidelines for the various phases and areas of disaster management (all are available online at <http://www.ndma.gov.pk>)

Provincial Governments have also made substantial progress in developing their own extensive processes for disaster management to facilitate an effective response.

In recent years a number of smaller but devastating disasters have struck various regions of Pakistan including, Khyber Pakhtunkhwa, Punjab, Sindh, and Balochistan. All have been responded to by both the National and Provincial Disaster Management Authorities, District Authorities, the Pakistan Armed Forces, and often, in the first instance, by the communities themselves. The humanitarian community and donors in Pakistan have when requested, provided funding and other support across

---

<sup>2</sup> [http://www.ndma.gov.pk/Documents/flood\\_2010/lesson\\_learned/Lessons%20Learned%20-%20Flood%202010.pdf](http://www.ndma.gov.pk/Documents/flood_2010/lesson_learned/Lessons%20Learned%20-%20Flood%202010.pdf)

multiple sectors, to supplement local response and early recovery work.

However, the potential remains, as it does for many countries in the region that some disasters are of such a scale that there is a need to reach out to other countries for assistance. The *Host Nation Support Guidelines* for Pakistan addresses the issues specifically related to requesting, receiving and managing foreign assistance in times of national crisis.

### ***Phases of Disaster Management***

- Preparedness and Mitigation
- Response, Rescue and Relief
- Early Recovery
- Rehabilitation and Reconstruction.

The need for foreign assistance generally occurs in the Response, Rescue and Relief phase. Foreign assistance could include the provision of any or all of the following:

- Funding
- Field Hospitals
- Non-Food Items (NFIs)
- Food
- Humanitarian Personnel
- Medical Teams
- Military Personnel and Assets (e.g. Aviation and Medical)
- Search and Rescue Teams
- Technical Experts and Specialist Teams

Highest priority is placed on services that provide life-saving sectors assistance:

- Food
- Health
- Shelter
- Water and Sanitation (WASH)

### **Epidemics and Pandemics**

Epidemics are a serious risk in disasters often known as ‘the second wave’. Due to rapid medical assistance provided by responders during previous disasters in Pakistan, there has never been a ‘second wave’ health disaster.

Temporary displacement of populations can also lead to transmission of diseases from one area to another. This was identified as a risk when the poliovirus was carried by temporarily displaced persons (TDPs) from cities like Karachi back to their home areas. Dengue and malaria also present additional risks during emergencies and displacement.

Pakistan is also potentially vulnerable to epidemics which can sweep across the country in such a way that the local capacity could be overwhelmed. To date, this has not happened but like all countries, particularly developing ones, considerations must always be made and constantly updated on how to respond in such a crisis. The Guidelines contain a section for foreign medical assistance.

## Using the Guidelines

For simplicity and ease of reading, the Guidelines are divided into eleven sections to identify the processes, stakeholders, roles, guidelines, and principles. Although each section is self-contained, it is recommended that all stakeholders review all the sections of the Guidelines to gain an understanding of all the aspects of international assistance.

## Challenges in Foreign Assistance in Response

There are a number of challenges that always arise during the response phase. These Guidelines aim to reduce the delays such challenges cause by addressing the procedures that need to be followed to avoid chaos. The following points are taken from lessons learned from past disasters and consultations with stakeholders to develop the Guidelines:

- Delays in requesting foreign assistance
- Access to the generated response and to the field
- Civil-Military coordination in humanitarian sector
- Coordination between National and Provincial levels
- Customs procedures
- Communications and information sharing
- Different and overlapping mandates
- Differing and confusing terminologies
- Differing perspectives on sovereignty issues
- Duplication of relief in some areas and no assistance in others
- Unsolicited/non-required relief goods
- Inappropriate relief consignments - non-Halal / expired food items, out-of-date medicines, culturally unsuitable attire, and dietary issues
- Insensitivity to local culture and customs
- Language differences
- Lack of Standard Operating Procedures (SOPs) for disaster/foreign response in Government Ministries, Departments and Organisations
- Log jams at air and sea ports
- Logistics delays
- Non-observance of NOC restrictions

- Tensions between UN and Government of Pakistan in relation to guidelines and use of military assets for delivery of relief.

## Definitions

**Assisting Country:** The term Assisting Country describes a bilateral response from a particular country which may include a multi-agency or ‘whole-of-government’ deployment of required civil-military expertise and potentially, military assets, at the request of the government of the host country.

**Host Country:** The Host Country, which is where the disaster occurs, should be the first and pre-eminent authority in disaster response. In general, there will be no international response unless at the express request of the host country and upon their acceptance of international offices of assistance. International response, once provided, is expected to respect host country ownership and leadership.<sup>3</sup>

**CIMIC (Civil-Military Cooperation)<sup>4</sup>:** The coordination and cooperation, in support of the military mission, between the Force Commander of the Host Nation military, and civil actors, including the national population and local authorities, as well as international, national and non-government organisations (NGOs) and agencies.

**Civil-Military:** In the context of a humanitarian response the term “*Civil-Military*” refers to the relationship between the humanitarian community and the military.

**Civil-Military Coordination (CMCoord):** UN Humanitarian Civil-Military Coordination (UN CMCoord)<sup>5</sup> : The term expressly refers to the coordination between the humanitarian sector and military actors during a disaster response. When an emergency or natural disaster creates humanitarian needs, many countries, with prior express acceptance of host country government, will deploy their militaries or paramilitary organizations to respond. Bilateral support to disaster-affected States can also be provided through international deployment of foreign military actors and assets. When local and international humanitarian organizations are also involved in that response, it is essential that they can operate in the same space without detriment to the civilian character of humanitarian assistance.

**Early Warnings:** The set of capacities needed to generate and disseminate timely and meaningful warning information to enable individuals, communities and organisations threatened by a hazard to prepared and to act appropriately and in sufficient time to reduce the possibility of harm or loss.

**Humanitarian Community:** The term ‘humanitarian community’ brings together a diverse group of organisations and individuals who provide assistance in times of disasters and other emergencies.

**Emergency Medical Care:** Health care of all age groups, with injuries or acute health care requirements. It includes the initial assessment, resuscitation, operative (and anaesthetic) care, postoperative care and rehabilitation of the injured as well as emergency care of any associated co-morbidities or illness.

**FMT:** Foreign Medical Team

**MIRA:** Multi-Sector Initial Rapid Assessment: The Multi-Sector Initial Rapid Assessment (MIRA) is the first step of the Assessment and Monitoring Framework, and was designed to identify strategic humanitarian priorities after the onset of natural disasters or other emergencies. MIRA covers the

---

<sup>3</sup> Australian Civil-Military Centre. Same Space – Different Mandates (International Edition). 2015.

<sup>4</sup> AJP-9 NATO Civil-Military Co-Operation (CIMIC) Doctrine, July 2003.

<sup>5</sup> <http://www.unocha.org/what-we-do/coordination-tools/UN-CMCoord/overview>

complete cycle of assessments, starting from the initial Situation Overview to the Monitoring and Evaluations by the end of early recovery.

**Primary Care:** Primary health care is health care received in the community, usually from family doctors, community nurses, staff in local clinics or other health professionals. It should be universally accessible to individuals and families by means acceptable to them, with their full participation and at a cost that the community and country can afford.

**Relief:** The provisions of goods and services to provide relief to affected communities in the immediate aftermath of a disaster. Different organisations may use the terms ‘relief’ and ‘response’ for the same meaning.

Response: Actions taken directly before, during, or immediately after a disaster in order to save lives, reduce health impacts, ensure public safety and meet the basic subsistence needs of the people affected. (United Nations Office for Disaster Risk Reduction (UNISDR) 2017.)

Response means the provision of assistance curing or immediately after a disaster to reduce loss of life and property, and deliver humanitarian assistance including, but not limited to:

- Provision of lifesaving emergency medical care
- Search and rescue assistance
- Rapid disaster impact assessment
- Emergency management expertise,
- Water and sanitation
- Food
- Hygiene
- Shelter
- Communications
- Transport
- Utilities repair and reconnection

**Whole-of-Government:** Public Sector agencies working together across boundaries of their mandates, sometimes with military, to provide an integrated response to disasters.

## Host Nation Coordination

### National Disaster Management Act 2010

The *National Disaster Management Act 2010*, Chapter V, Section 23, Para.(2), establishes the responsibility of the Federal Government to take responsibility for all measures it deems necessary or expedient for the purpose of disaster management including:

- Para.(c) – the requisition and deployment of armed forces, civil armed forces or any other civilian personnel OR foreign contingents required for the purposes of this act; and,
- Para.(d) – coordination with the United Nations’ agencies, international organisations and governments of foreign countries for the purpose of this Act.

Pakistan also has a *National Disaster Management Plan (2012)* but although it has sections on Foreign Assistance (5.2.3 and 6.2.3) these points also do not prescribe the full considerations required for foreign assistance.

#### ***Activities on Accepting Foreign Assistance.*<sup>6</sup>**

- Preparation of the Roster of Volunteers - NDMA, P/S/G/F DMAs and DDMA as well as relevant agencies, shall prepare the rosters for volunteers and CBO to support the assessment and rescue/relief activities in the affected areas.
- Preparation of the List of Donations / Relief Goods to be Accepted - NDMA, P/S/G/F DMAs and DDMA shall prepare the list of donations to be accepted and the procedure for use of donations in advance.
- NDMA in association with the Ministry of Foreign Affairs shall make a plan for the distribution protocol of foreign donations.

The following sections provide a step-by-step list of actions to be taken at national level to prepare for, request, receive, and manage foreign assistance in the event of disasters which exceed national capacity. In the preparedness process for any future disaster, a multi-tiered chain of decision-making for requesting and receiving foreign assistance should be formally determined and officially notified.

### National Disaster Management Authority (NDMA)

Under the National Disaster Management Act, National Disaster Management Authority (NDMA) is the

---

<sup>6</sup> NDMP. Sections 5.2.3 and 6.2.3

designated coordinating and policy agency at the Federal level to deal with the all aspects of Disaster Management activities. In the event of a major disaster NDMA will be the principal coordinating authority.

In the event of a disaster, all stakeholders including Government Ministries, Departments, Provincial Disaster Management Authorities, Armed Forces, INGOs, NGOs, UN Agencies coordinate through NDMA to conduct a one-window operation.

NDMA was established under the National Disaster Management Act – 2010 and functions under the supervision of National Disaster Management Commission (NDMC) which is headed by the Prime Minister of the Islamic Republic of Pakistan. Currently, NDMA operates under the Prime Minister's Office. The National Disaster Management Act 2010 gives national level responsibility for coordination of natural disasters, to the National Disaster Management Authority (NDMA). NDMA's mandate in emergency response is to:

- Act as the implementing, coordinating and monitoring body for disaster management.
- Provide necessary technical assistance to the Provincial Governments and the Provincial Authorities for preparing their disaster management plans in accordance with the guidelines laid down by the National Commission.
- Co-ordinate response in the event of any threatening disaster situation or disaster.
- Lay down guidelines for or give directions to the concerned Ministries or Provincial Government and the Provincial Authorities regarding measures to be taken by them in response to any threatening disaster situation or disaster.
- For any specific purpose or for general assistance requisition the services of any person and such person shall be a co-opted member and exercise such power as conferred upon him by the Authority in writing.
- Perform such other functions as the NDMC may require it to perform.

The Operations (OPS) Wing of NDMA, is responsible for the following activities in disaster response including foreign assistance:

- Manage National Emergency Operations Centre (NEOC).
- Supervise and Coordinate Relief and Rescue Operations (Pakistan and Foreign Responders).
- Prepare situation updates and briefings.
- Make contingency plans for the country.
- Supervise all matters related to Urban Search and Rescue (USAR) teams.
- Prepare briefs and presentation for the Prime Minister, President, Members of Senate, the National Assembly and other dignitaries.
- Coordinate relief efforts with Federal and Provincial Authorities, Armed Forces and humanitarian organisations.
- Prepare Contingency Plans for all types of disasters.
- NDMA will also be a member of the National Emergency Telecommunication Coordination Team (NETC). NETC will monitor and evaluate the overall operation regarding Emergency telecommunication services during disasters.





## NDMA Structure

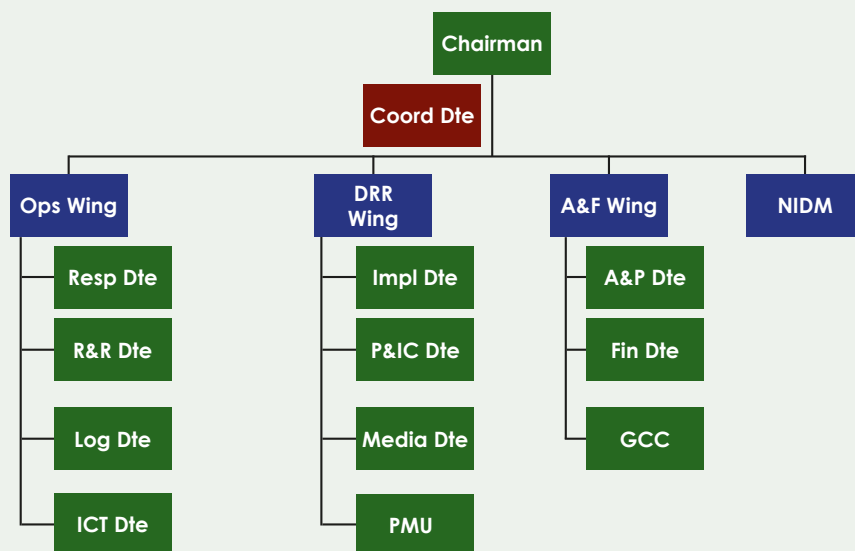

### *NDMA Coordination Meetings*

In the event of a large-scale disaster, NDMA will organise regular coordination meetings for representatives of the key responders to ensure all are aware of the daily situation and gaps in response to ensure effective response.

## Needs Assessments

NDMA will coordinate the process of conducting needs assessments in disasters in coordination with various stakeholders. Although the impact may vary considerably from one disaster to another, typical needs that arise include:

- Food
- Shelter
- Essential items, such as bedding, blankets, heaters, water containers
- Household Items
- Medical care
- Medicines and other health items
- Safe drinking water
- Water and Sanitation
- Waste disposal
- Boats, Outboard motors, life jackets

- Damaged infrastructure
- Psychosocial support

**Note:** In the event of a major industrial or technical disaster, foreign responders should engage with NDMA to coordinate on the possible provision specific technical needs such as HAZMAT and other protective suits and specialised equipment.

## **Multi-Sector Initial Rapid Assessment (MIRA)**

In 2012, the National Disaster Management Authority (NDMA) and the Humanitarian Country Team (HCT) agreed to develop and adopt an Assessment and Monitoring Framework for Pakistan. The Assessment Working Group (AWG), co-chaired by NDMA and OCHA, was mandated to develop and propose guidelines for this purpose. Subsequently, AWG in consultation with NDMA, Provincial Disaster Management Authorities (PDMAs), relevant government institutions, clusters and UN agencies drafted framework, tools and methodology for coordinated assessments.

The Assessment and Monitoring Framework covers the complete cycle of assessments, from the initial Situation Overview to the Monitoring and Evaluations by the end of early recovery. The Multi-Sector Initial Rapid Assessment (MIRA) is the first step of the Assessment and Monitoring Framework, and was designed to identify strategic humanitarian priorities after the onset of disasters.

MIRA has been conducted in Pakistan twice after the floods of 2012 and 2014. MIRA- 2014 lessons learnt exercise highlighted two major grey areas in implementation including the non-availability of trained enumerators at the time of assessment and a lack of validation mechanism. Subsequently, rounds of revisions were conducted to keep MIRA up-to-date and relevant in emerging situations.

The Guidelines for MIRA have been developed by NDMA with technical support of UNOCHA to provide operational guiding principles on roll-out and implementation of MIRA. The approach adopted for these Guidelines is inclusive, comprehensive, decentralized and focused on institutionalization of initiatives. The MIRA Methodology Document was exclusively consulted for the development of these Guidelines. The full MIRA Guideline can be accessed on the NDMA website at <http://www.ndma.gov.pk/publications/MIRA%20GUIDELINES.pdf>

### ***Timeline for MIRA Process***

Upon a request by the PDMA, NDMA shall ask AWG to undertake a situation overview (based on secondary data and other sources i.e. satellite imageries/remote sensing etc.) within 24-72 hours of the onset of a disaster. However, this timeline can be extended in exceptional circumstances by mutual consent of NDMA and UNOCHA.

Within 7 days, a field assessment will be carried out on community level to identify needs and priorities of the affected and vulnerable population.

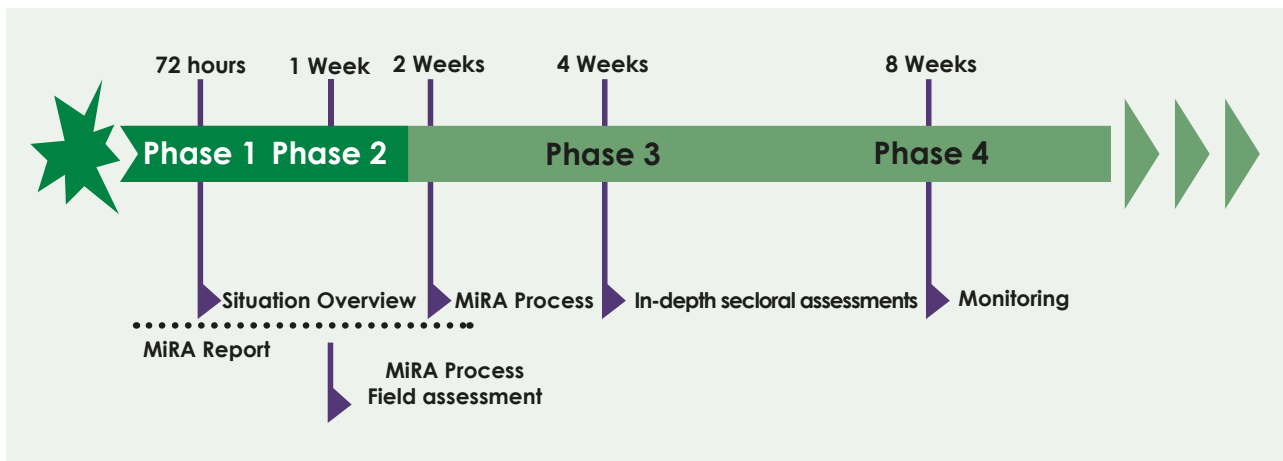

## When Foreign Assistance is Required

In the event of any rapid onset large-scale disaster such as an earthquake, cyclone, tsunami, epidemic, or similar catastrophic event, the Government of Pakistan will first call on all its own resources and capacities to respond. Pakistan has substantial capacity through the support of government stakeholders, the Armed Forces, and locally based humanitarian community.

However, when local capacity becomes overwhelmed by the scale of the catastrophe – as happened in the 2005 earthquake and 2010 floods – foreign assistance becomes essential. It is a significant step for any government to take, as it requires massive coordination, special rules and procedures, security considerations, and a range of issues which make it a complex process.

It is generally recommended that when local capacity is reaching no more than 80 percent, immediate steps should be taken to prepare to request specified foreign assistance rather than waiting till local capacity is overwhelmed.

The Prime Minister may appeal for Foreign Assistance at any time in the first 72 hours or thereafter if information and assessments from the field indicate that the scale of the disaster is such that local capacity to respond with life-saving assistance will be immediately overwhelmed. Three main stakeholders – Economic Affairs Division/Ministry of Finance, Ministry of Foreign Affairs, and NDMA – will advise the Prime Minister in this instance.

# Pakistan's Hierarchical Response Strategy

NDMA being the lead coordinating agency at Federal Level, has a well developed coordination mechanism with lateral linkages with Pakistan Armed Forces.

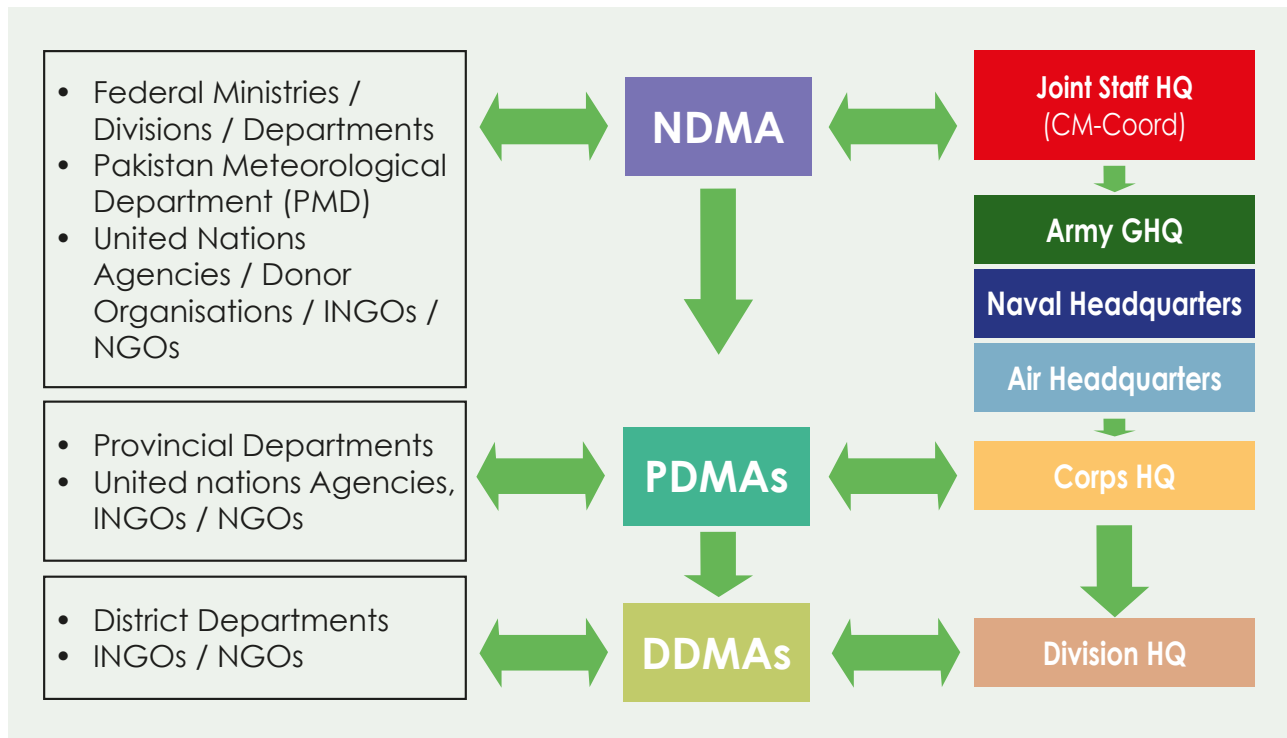

## Section

# 3

## Overarching Principles for Foreign Assistance

1. Provision of humanitarian assistance must respect the sovereignty of the Islamic Republic of Pakistan being the Host Nation.
2. Upon an offer of foreign assistance, the embassy of the Assisting Country must ensure prior coordination through appropriate channels with all stakeholders including Ministry of Foreign Affairs, Ministry of Interior, Economic Affairs Division, intelligence agencies and Joint Services Headquarters to align with specific requirements.
3. Foreign aid workers, especially armed forces personnel, must be kept to the minimum.
4. The concerned Ministry must ensure that a detailed list of foreign rescue and relief workers (and their core skills) is shared with Ministry of Foreign Affairs, Ministry of Interior (Visa Section), and Law Enforcement Agencies (LEAs), for necessary scrutiny and clearance.
5. Foreign organisations core skills and qualifications of each member of all response teams including search and rescue, medical teams, and other specialists, must be notified to NDMA and the concerned Ministries, and for sharing with PDMAs, for approval before deployment to Pakistan.
6. Should the assistance of foreign militaries be requested or offered, Joint Services Headquarters in coordination with each arm of the military, will make the decisions on the precise requirements and rules for participation and coordination.
7. The lead role for coordinating Army's response to undertake rescue and relief operations in collaboration with foreign military teams may rest with GHQ–Military Operations Directorate, in coordination with NDMA, Navy and Air Force.
8. Foreign Military assistance SOPS, ROE's, procedures, rules, responsibilities and coordination points may be prepared in consultation with relevant stakeholders for dissemination to all Services and stakeholders.
9. To eliminate problems that occurred in previous disasters due to misunderstanding of international civil-military guidelines, there is a need to formulate localised guidelines for Pakistan.

10. In preparedness for disasters, workshops, seminars, trainings and simulations to acquaint military elements, especially Urban Search & Rescue Teams (USAR), with international guidelines of civil-military coordination, may be conducted regularly.
11. A Joint Aviation Coordination Cell (JACC) will be implemented in coordination with NDMA to coordinate the movement of aviation assets to ensure rapid movement of relief goods) with representation from all three services – Army, Navy and Air Force – when providing air assets. *(See Section 6 for further information).*
12. Restrictions on dual purpose technical equipment will be defined by relevant stakeholders.
13. Weapons of any kind are prohibited from being brought into the country.
14. International Non-Government Organisations (INGOs) must be registered with the Ministry of Interior and apply for a No-Objection Certificate (NOC) to operate in Pakistan.
15. Security clearances for all Foreign Humanitarian Organisations and Military Contingents must be sought from relevant authorities prior to deployment.
16. UN agencies, INGOs and other responders **may not be allowed** to bring in integral communication equipment. In case of specific need for field operations, compatibility parameters with host Army formations must be assured and clearance by the Ministry of Information Technology and Telecom (MOIT) and the Pakistan Telecommunications Authority (PTA).
17. Prior to deployment of aviation assets to disaster-affected areas, coordination of routes and type of aviation support must be agreed the Joint Aviation Coordination Cell (JACC) (see Section 6), Civil Aviation Authority (CAA), Army Aviation Command, Pakistan Air Force (PAF), Navy Aviation Command, and Inter Services Intelligence.
18. Upon arrival in Pakistan of personnel from **approved** International NGOs (INGOs), a detailed briefing encompassing area orientation and cultural aspects must be arranged by NDMA. Pakistan has diverse cultures which vary across the country. All briefings for responding organisations and personnel must include a briefing on the cultures and religious beliefs of the nation and designated areas of operation before proceeding with response activities. These must be respected. A brochure/briefing paper with information contributed from both NDMA and PDMA should be provided for this purpose by the Government of Pakistan through Pakistan Overseas Missions.
19. Foreign Humanitarian Organisations and Military Contingents operating in the field should not have direct/unescorted interaction with the local population. Government and/or Armed Forces personnel should accompany as their local liaison.
20. Limitations for the conduct of operations in restricted areas and installations Humanitarian Organisations and Military Contingents will generally apply.

21. Foreign Humanitarian Organisations and Military Contingents will liaise with the NDMA Coordination Cell for Humanitarian Relief
22. Any Search and Rescue Animals entering the country must have up-to-date certification papers. Involvement of organisations such as Rescue 1122 in Punjab, Balochistan, Khyber Pakhtunkhwa, Gilgit Baltistan and Azad Jammu & Kashmir, in the utility of SAR animals may be valuable.
23. Food items being brought in as relief items must be scrutinised with respect of expiry date and Halal certification.
24. All food and medicinal relief items must have an expiry date/period of at least one year.
25. Humanitarian assistance must be provided fairly and equitably across all affected communities.
26. Only requested relief items will be accepted. Full details and procedures will be available on the NDMA website along with the Guides for Supply and Logistics<sup>7</sup>
27. Wherever possible, responding countries and organisations should source relief goods in Pakistan to support the recovery of the local economy, reduction in shipping costs, and ease of logistics.
28. Humanitarian organisations providing cash or voucher support to affected communities instead of relief goods, must first seek approval from relevant Government authorities (such as EAD) and NDMA.
29. Users of electronic media including social media, should ensure that there is no breach of any local rules related to broadcasting or the Prevention of Electronic Crimes Act 2016.
30. The religious, cultural, and other local sensitivities, and the dignity of all affected persons including women, children, the elderly, disable and vulnerable must be respected.
31. Minimum standards for humanitarian response as defined in accordance with national and international laws and standards, UN Resolutions, and international guidelines such as the Core Minimum Standards and Sphere Guidelines must be respected.
32. Response activities should be in harmony with the requirements for the early recovery stage, and future rehabilitation and construction.
33. The safety and security of response personnel is a priority for the Government of Pakistan. Response teams must follow all official safety and security advice, rules and procedures, in relation to movement and field operations, and comply with any orders to move from an area.
34. As the response phase draws to a close, or the end of a specific phase of disaster response, the Government of Pakistan through the National Disaster Management Authority will notify all stakeholders of the end date for foreign assistance, handover, and departure.

---

<sup>7</sup> <http://www.ndma.gov.pk/publications/NDMA-Guidelines.pdf>

35. The Assisting Agencies and Countries must respect the priorities and decisions of the Guidelines of the NDMA issued on behalf of Government of Pakistan, including timelines for the closing of one phase of response to the initiation of another phase.
36. Applicable local law will apply to foreign personnel (civil and military).
37. All latest disaster information will be available on the National Disaster Management Authority (NDMA) website <http://www.ndma.gov.pk> and regularly updated.



## Section

# 4

## Guide for Government of Pakistan Stakeholders

### Preparedness

- NDMA should be fully empowered and resourced to coordinate and monitor rescue and relief efforts at national level.
- Ensure all warehouses across the country are always stocked with relief items in preparedness for any disaster
- NDMA should conduct periodic table-top exercises with all relevant stakeholders for response and coordinating international assistance
- Prepare and update contingency plans for all types of disasters
- Government Ministries, Departments and Authorities should prepare a set of Standard Operating Procedures (SOPs) for disaster response including managing any foreign assistance
- Clear definition of roles and responsibilities of all parties including Government, NDMA, PDMA, DDMA, Military, UN, humanitarian agencies and civil sector need to be identified and communicated prior to any disaster response.
- Disaster response facilities (similar to the Humanitarian Response Facilities) established by NDMA, PDMA and WFP, should be established in identified areas where there is no Army presence and equipped to provide immediate assistance.

### When the Disaster Strikes

- At the outset of the disaster, the Government of Pakistan, NDMA, and all stakeholders, should decide and communicate the nature, quantum, and timing for relief, and the benchmark for calling for foreign assistance.
- Government Ministries, Departments and Agencies should appoint and declare/advertise the Focal Point for contact and liaison with NDMA and relevant stakeholders
- Review and activate all internal Standard Operating Procedures (if available) and share with all stakeholders
- Major stakeholders to deploy liaison officers to NEOC (NDMA) to ensure smooth inter-agency

cooperation and sector expertise

- A dedicated team within NDMA, with assistance from Foreign Office and Health Ministry, should be deployed at airports and other entry points to assist with incoming relief flights
- Map the affected areas to provide a visual representation of areas, needs, and responding organisations
- Implement any contingency plans
- A Joint Aviation Coordination Cell should be immediately be formed by NDMA comprising but not limited to Civil Aviation, PAF, Pakistan Army and NDMA to coordinate effective efficient use of aviation assets and logistics.
- Foreign militaries should be advised through their Military Attaches, of the need to also engage with NDMA as well as Pakistan Armed Forces prior to deployment to ensure adequate equipment is included in the deployment, and to acquaint themselves with the national priorities

## Monitor, Assess and Implement

- Monitor the situation and alert all authorities to prepare for a rapid and extensive response
- Continuously assess the availability of assets, supplies, and personnel
- Activate the National Emergency Operations Centre (NEOC)
- Notify Customs, Immigration and Quarantine procedures to prepare for the possibility of foreign relief consignments. Where necessary special desks/counters should be established at all ports of entry
- NDMA, in coordination with other agencies including PDMA, UN and humanitarian agencies (as required), will conduct an immediate assessment of the scale of the damage, the number of affected people, and the needs for relief assistance
- NDMA will communicate the scale of the disaster to the relevant Government Ministries and Departments, and to the public.
- NDMA will provide regular situation reports from the field to all stakeholders
- Ministry of Foreign Affairs (MOFA) will advise all foreign missions in Pakistan and Pakistan missions overseas of the scale of the disaster and the specific needs for assistance.
- MOFA will make formal request for assistance required, including:
  - Search and rescue teams
  - Foreign medical teams
  - Initiate simplified customs, immigration and quarantine procedures
  - Identify requirements for temporary recognition of professional qualifications, accreditations and registrations, in particular Search and Rescue Teams and Foreign Medical Teams
- NDMA, Ministry of Health, Other relevant Ministries/Departments to advise temporary recognition for practice for disaster response personnel.

## Communicate

- Communicate the identified roles and responsibilities of all stakeholders including Government, NDMA, PDMAs, DDMA, Military, UN, humanitarian agencies and civil sector to the public at the outset of the disaster.
- Communicate the zones and magnitude of the disaster to the public
- Notify and prepare personnel for deployment to affected areas
- Advise Pakistan Overseas Missions of the possible need for foreign assistance
- Advise Foreign Missions in Pakistan over the possible need to provide assistance
- Media - the media should be briefed to gain a full understanding of the challenges of humanitarian response and need for reporting sensitively so as not to create panic.
- Funding Appeals:
  - Assess the need for an international funding appeal
  - Discuss with Government and Humanitarian Organisations (in particular UN RC and OCHA)
  - Launch appeals to domestic and international sources along with propagation of procedures.

## Respond to Offers of Assistance

- MOFA to formally respond, in coordination with NDMA, to offers of assistance on behalf of Government of Pakistan based on needs assessments provided by NDMA, and Pakistan Armed Forces (for foreign military assistance)

## Receive

- Identify entry points for response teams
- Prepare briefing teams for arriving response teams (NDMA and UN)
- Initiate Joint Aviation Coordination Cell (JACC) if required – NDMA, Civil Aviation Authority and JSHQ
- Provide Briefing for arriving disaster response personnel – NDMA
- Provision of facilities and security
- Check temporary recognition acceptance of professional qualifications, accreditations and registrations
- Provide temporary transport and other logistics arrangements
- Provide temporary accommodation for personnel at points of disembarkation before moving to field
- Provide temporary warehousing at points of off-loading
- Costs should be clearly identified and communicated

## Manage

- NDMA should be the first point of contact for donors/philanthropists in a disaster situation to facilitate contact and dialogue with all appropriate authorities including PDMAs and DDMA to ensure equitable distributions of goods to areas most in need, provide guidance and encourage communication.
- NDMA will hold regular coordination meetings with key stakeholders to ensure a common operating picture and to identify and rapidly address gaps in the response.
- NDMA should maintain a database/ inventory of all the relief stores available through all the stakeholders including government departments. The same can be released to field operators for their awareness.
- NDMA will develop SOPs for emergencies to enable Pakistan Missions to provide clear guidelines on points of contact, appropriateness of relief items, cost to Pakistan of transporting and handling relief goods and other relevant issues to be addressed when responding to offers of assistance.
- UN Agencies must consider and respect the wishes and imperatives of the Government of Pakistan in preparing, supporting launching appeals for future disasters.
- NDMA, in consultation with donors, should assist local NGOs to build their governance capacity and develop appropriate standards to facilitate more direct funding from donors for disaster management.
- Donors should be further encouraged to prioritise funding in consultation with NDMA to maximise aid effectiveness and inclusiveness.
- Donors should be encouraged to contact NDMA prior to shipment of relief goods to ensure appropriateness of the cargo and to facilitate smooth entry and distribution.
- Efforts should be made to more effectively engage with philanthropists and the business community to encourage more even distribution of relief and to assess the scale of contributions to relief efforts through non-formal channels.
- GoP/NDMA should emphasise timely strategic decision-making in disasters and ensure compliance with decision-making timelines from all humanitarian actors particularly the UN.
- Ensure fair and equitable distribution of relief.
- Map the locations and assistance required to rationalise and optimize the assistance needed and delivered

## Terminate Response

- The Government of Pakistan will decide on the advice of NDMA when the local capacity is able to manage without further foreign assistance.
- NDMA will notify all foreign responders of the final date to hand over to the national organisations and to depart Pakistan
- NDMA will request reports from all response organisations to assist in the development of Lessons Learned.

## Section

# 5

## Government Key Stakeholders

### Key Government Ministries and Departments

A number of Government Ministries and Departments play important roles in facilitating foreign assistance. However, most Government Ministries and Departments do not have specific Standard Operating Procedures (SOPs) or internal Guidelines for disaster management/response. Some recommendations are also included in this section for consideration by various Government stakeholders to assist in addressing any gaps in preparedness.

#### **Ministry of Finance – Economic Affairs Division (EAD)**

The Economic Affairs Division (EAD) responsibilities include engagement with foreign donors and countries for resource mobilisation and donor coordination on behalf of Government of Pakistan.

EAD is responsible for assessment of requirements, programming and negotiations of external economic assistance related to the Government of Pakistan and its constituent units from foreign Governments and multilateral agencies. It plays a key role in coordinating with donors to facilitate the flow of funds into Pakistan for relief projects. Apart from bilateral funding, EAD is a lead division in the preparation, negotiation and launch of the various appeals for funds for relief, recovery and reconstruction. EAD also handles matters relating to technical assistance to foreign countries and monitoring and accountability of aid funding utilisations.

#### **Ministry of Foreign Affairs (MoFA)**

The Ministry of Foreign Affairs (MoFA) is the main focal point for the Government of Pakistan for international engagement related to offers of assistance in major disasters.

MoFA's responsibilities include resource mobilization through presentation of the unfolding scenario to the international community, coordinating with the UN, working closely with Foreign Missions in Pakistan, and also the Pakistan Overseas Missions, to facilitate the flow of aid to Pakistan. The specific needs of the affected communities will be provided to MoFA by NDMA for communicating to the Foreign Missions in Pakistan, and to Pakistan Overseas Missions to ensure that only the aid that is required is sent as unsolicited aid is a costly and logistical problem for a host country. MoFA may also provide a Liaison Desk within NDMA during the response phase.

In conjunction with Economic Affairs Division (EAD) and NDMA, MoFA is also involved in the planning of any Government or UN Appeal, arranges VIP visits from the leadership of donor countries, and liaises with various bilateral and multi-lateral donors providing assistance throughout the response phase.

- MOFA should establish its own Disaster Coordination Cell for coordination with foreign missions.
- All Pakistan Overseas Missions should have a designated officer to deal with the host government in the event of disaster, both in that country or at home.
- Pakistan Overseas Missions could be provided with a brochure on Pakistan, geography, government mechanisms, cultural sensitivities and other helpful issues for distribution to foreign responders prior to their deployment
- MoFA may develop its own internal guidelines for functioning in the face for natural disasters.
- At the outset of a disaster, a MoFA officer may be deployed to NDMA to assist with relevant coordination matters.
- The Host Nation Support Guidelines document should be available in all Pakistan missions for use in such an eventuality. It could also be uploaded on embassy websites.
- NDMA, MoFA and Joint Services Headquarters (JSHQ) may have periodical Table Top Exercises in consultation with all other relevant government agencies as well as major foreign donors and organisations dealing with disaster preparedness.

## Ministry of Interior

The Ministry of Interior (MOI) is responsible for important components of entry and working in Pakistan for foreign nations. In relation to foreign responders for disasters, these include:

- Visas for foreigners (through the Political External Wing)
- INGO registration (see “INGO Policy” below)
- Visits to restricted areas (NOCs)
- Funding approvals (through the Political External Wing)

### *Visas*

All visitors to Pakistan—including humanitarian responders—must receive clearance from MOI for visas **before** travelling. Visas will not be issued on arrival. Federal Security Agencies and Provincial Special Branch of Police are involved in the clearance process. For nationals of some countries, there is a requirement to report to the nearest Police Station within 24 hours of arrival in Pakistan.

MOI in consultation with MOFA, and NDMA, may amend specific guidelines for visas and movement of foreign relief workers in Pakistan depending on the overall requirements of response to the possible disaster scenario within the first few days of the disaster.

### *INGOs – Special Policies*

MOI has special policies and rules for registration for INGOs that must first be met. **Please see Section “INGO’s Policies & Rules” for further information.**

When the need for foreign assistance is identified, Ministry of Interior may (as noted in Para 7.4 of the INGO Policy <https://ingo.interior.gov.pk/>), immediately review the INGO policy at the discretion of the Government of Pakistan to decide whether special concessions for entry of INGOs could be made subject to clearances, for a defined period of time, to support the national capacity.

## *No Objection Certifications (NOCs) and Security Procedures*

**For No Objection Certificates (NOCs) to visit restricted areas**, Federal Security Agencies and Provincial Branch of Police, are involved in the clearance process. No INGO or foreign response organisation is permitted to move in certain areas without an NOC.

The Ministry of Interior is also responsible for the Pakistan Rangers, Frontier Corps, Frontier Constabulary, Coast Guard and Civil Defence, all of which may participate in disaster response.

## **Federal Board of Revenue (FBR) – Customs Wing**

The **Customs Wing** of the Federal Board of Revenue (FBR) is responsible for all arrangements for entry of relief goods, and for any gifting of equipment at the end of a disaster-related deployment. **It is advisable that assisting countries/organisations make contact with NDMA (Logistics Section) and the Customs Wing prior to any deployment where goods or equipment are involved, to ensure documentation is in order to facilitate prompt clearance.**

The role of Pakistan Customs in facilitating disaster response is summarised in Annex 1 to assist with a swift and smooth clearance process for relief goods arriving by air, sea, or land.

## **Ministry of Maritime Affairs**

**The Ministry of Maritime Affairs**<sup>8</sup> provides assistance to facilitate the speedy release of foreign relief cargo. The Ministry will also consider/process applications of waivers of port and demurrage charges on foreign relief goods donated by the humanitarian community or imported by the GoP throughout the relief phase.

## **Pakistan International Airlines (PIA)**

Pakistan International Airlines (PIA) has in the past, provided transportation of relief goods from abroad and within Pakistan. In the 2010 super floods, PIA announced free transportation of relief goods from any place in the world to airports in Pakistan. PIA formed a Flood Relief Project and activated PIA's Emergency Report Centre at Karachi to facilitate overall coordination and collection of relief goods, set up a web page to guide donors and the community and Help Desks throughout the PIA network. In addition, the national carrier mobilised the international community through an aggressive media campaign of videos, television and print media. PIA also facilitated free handling of charter flights and storage of their relief goods at PIA warehouses in Pakistan and abroad. In the event of any future disaster, the airline may again be a source of assistance in transportation of relief goods.

## **Pakistan Meteorological Department (PMD)**

**The Pakistan Meteorological Department (PMD)**<sup>9</sup> is both a scientific and a service department, under the Cabinet Secretariat (Aviation Division). PMD is responsible for providing meteorological services across Pakistan to a wide variety of interests and for public activities and projects which require climatic information. PMD also provides services in hydrology, earthquake seismology and geomagnetism. PMD provides Early Warning and updated weather information available through their website and NDMA. (See Annex 2 for more details on PMD's mandate)

---

<sup>8</sup> <http://www.mops.gov.pk/>

<sup>9</sup> [www.pmd.gov.pk](http://www.pmd.gov.pk)

## Ministry of Information Technology and Telecom (MOIT)

MOIT's mandate is to ensure availability of accessible, affordable, reliable, universal and high quality ICT services. The Pakistan Telecommunications Authority (PTA) is the key authority under MOIT in relation to the approval, import and usage of ICT equipment.

## Pakistan Telecommunications Authority (PTA)

PTA<sup>10</sup> deals with ICT terminal equipment, its type approval and for other communication devices its authorisation for use within certain parameters as specified in certification. PTA's mandate includes (but is not limited to) sections that are relevant to the import and use of ICT equipment by foreign responders in disasters:

- Regulate the establishment, operation and maintenance of telecommunication systems and provision of telecommunication services in Pakistan.
- Receive and expeditiously dispose of applications for the use of radio-frequency spectrum.
- Promote and protect the interests of users of telecommunication services in Pakistan.
- Investigate and adjudicate on complaints and other claims made against licensees arising out of alleged contraventions of the provisions of this Act, the rules made and licenses issued there under and take action accordingly.
- Perform such other functions as the Federal Government may assign from time to time.
- Help NDMA in dissemination of public service messages through SMS and other media. This will also include dissemination of early warning messages to the public.

### *Approval for Import and Use of ICT Equipment for Disaster Management*

During a disaster, parties wishing to import ICT/telecommunications equipment for use in their activities for disaster management, Type approval of the equipment will be exempted and only NOC will be issued by PTA".

For foreign responders wishing to import ICT equipment for use in their activities, the following is a list of the required documents to be provided for obtaining Type Approval and certification. This is also available on the PTA website [www.pta.gov.pk](http://www.pta.gov.pk).

- Application Form
- Application fee
- Model No. and marketing/brand name
- Equipment classification
- Undertaking from applicant that PTA Regulations/Directives will be followed
- Sample (1)
- After sales service facility/customer service centre

---

<sup>10</sup>[www.pta.gov.pk](http://www.pta.gov.pk)



- In case of a new company NTN, SECP, Company profile
- Test Reports
- EMC/EMI
- Safety
- RF Report for frequency based devices
- SAR report for handheld devices
- Functional Test Report
- Declaration of Conformity DoC
- Technical brochure
- GSMA TAC allocation for SIM-based devices
- Authorisation letter from manufacture for the distributor(s)
- Origin of manufacture
- Undertaking about encryption features on device from manufacturer
- Undertaking that user data within the devices would be secure and would not be used for mala fide purposes
- OS report from 3rd party lab for mobile devices

***Procedure for Encryption / Inbuilt Ciphering Devices Certification***

ICT related equipment is of two types. The first is one, which transmits information openly. Pakistan normally has no reservation for usage. However if equipment uses inbuilt ciphering or certain protocols to hide its transmission, then it has different procedures for its certification.

Should UN / INGOs / NGOs / foreign militaries wish to import and use equipment for response or existing operations which has built in encryption system, then such equipment must fulfil certain requirements and be approved for usage by the authorities.

***Requirements for Evaluation of Equipment Using Cypher and Coding Protocols.***

- Provision of ‘ Source Code’ and ‘Simulator’ of the subject equipment.
- Device performance features and developer claims, along with developer test results.
- Intended purpose of the device.
- Exact model number and targeted feature set of the device.
- Detailed specifications/features of the device.
- Details of the network and targeted operational environment of the device.
- The exact number of devices to be inducted, their location along with listing of additional equipment to be used alongside the device in the operational network.
- Results of trials conducted for the equipment, if any.

This information will be shared with MOFA, MOI, and Cabinet Division (NTISB) for evaluation and, if approved, a certificate will be issued for its use in country.

**IMPORTANT NOTE: ICT equipment to be used in the field by UN agencies, I/NGOs, foreign military response teams and others, must also comply with the requirements of Army Formations in the field.**

### ***Prevention of Electronic Crimes Act 2016***

In 2016, the Government of Pakistan enacted the Prevention of Electronic Crimes Act 2016.<sup>11</sup> The Act is far-reaching and covers all aspects of electronic and cyber crime. There are strict rules and significant penalties for breaching the Act. All foreign responders should be aware of the responsibilities expected by the Government under this Act (see footnote for link to copy of the Act<sup>12</sup>).

### **Ministry of Information, Broadcasting, and National Heritage**

The Ministry of Information, Broadcasting, and National Heritage<sup>13</sup> is the Government's official authority for information. The Information Minister is the official spokesperson of the Government and formal point of contact for national and foreign media.

Situation reports, information from the field, and other updates are provided by the National Disaster Management Authority (NDMA) to the Ministry of Information for dissemination. NDMA also conducts press briefings and issues press releases and other information on its own website.

The Ministry does not have specific official SOPs for disaster reporting. Disaster information is disseminated through two channels: Press Information Department (PID) and External Publicity Wing.<sup>14</sup> Media should be careful to properly verify information from the proper authorities to avoid spreading malicious rumours and creating panic.

### ***Press Information Department (PID)***

The PID's key role should be maintained in any future disaster as well as in preparedness exercises to ensure greater media facilitation. This is important in ensuring that the general public is aware of the magnitude of the disaster and precautionary measures that can be taken to mitigate and lessen the impact.

### ***Cyber Wing***

The Cyber Wing of the Ministry and PID may also be utilised as and when needed in relation to using social media for most effective dissemination of accurate and important messaging related to the disaster.

### ***External Publicity Wing***

The External Publicity Wing facilitates foreign press in Pakistan and any member of international press outside of Pakistan that wants information on disasters in Pakistan. The Wing verifies documents such as official letter of request for coverage by the media organisation.

<sup>11</sup> Government of Pakistan. Prevention of Electronic Crimes Act. 2016. [http://www.na.gov.pk/uploads/documents/1472635250\\_246.pdf](http://www.na.gov.pk/uploads/documents/1472635250_246.pdf)

<sup>12</sup> Government of Pakistan. Prevention of Electronic Crimes Act. 2016. [http://www.na.gov.pk/uploads/documents/1472635250\\_246.pdf](http://www.na.gov.pk/uploads/documents/1472635250_246.pdf)

<sup>13</sup> <http://infopak.gov.pk/>

<sup>14</sup> Ministry of Information, Broadcasting and National Heritage

**Foreign media not based in Pakistan must seek a Journalist Visa from the Pakistan Embassy in their home country.** The paperwork and visas of the team wishing to travel to Pakistan for reporting purposes are then scrutinised by the various authorities. Approved journalists are granted visas from the Pakistan Mission in their home country.

**Field Access:** Access to information from the field may be restricted for foreign media (as it is for local press) depending on the situation on the ground. Media visits can be a distraction in an emergency. Field visits to affected areas may be arranged and coordinated with field organisations by the Information Ministry subject to situation, and various clearances, and an NOC.

### ***National Disaster Management Authority (NDMA) – Media Cell***

The National Disaster Management Authority (NDMA) also holds regular press conferences to keep media updated during the emergency phase and provides updates on their website and social media pages (including Facebook and Twitter).

### ***Inter-Services Public Relations (ISPR) – Pakistan Military***

The Foreign Media Section of Inter-Services Public Relations (ISPR)<sup>15</sup> is the official contact point for all foreign media engagement related to military matters.

### ***Pakistan Electronic Media Regulatory Authority (PEMRA) – Laws on Disaster Reporting***

Journalists should note that the Ministry of Information, Broadcasting and National Heritage issued Code of Conduct 2015 for amendments in the Pakistan Electronic Media Regulatory Authority (PEMRA) Rules, 2009, under which the electronic media has been directed to ensure that no hate speech is aired in any of its programmes.

## **Ministry of National Health Services, Regulation and Coordination**

Responsibility for planning and implementation of health programmes as well as service delivery was devolved to the Provinces in 2010 under the 18th Amendment of the Constitution of Pakistan. In the event of a disaster, the Provincial Health Authorities will also play a substantial role.

At National level, the Ministry of National Health Services, Regulations and Coordination has responsibility for:

- Efficient, equitable, accessible and affordable health services to support people and communities to improve their health status
- National and International Coordination in the field of Public Health
- Oversight for regulatory bodies in health sector
- Population welfare coordination
- Enforcement of Drugs Laws and Regulations
- Coordination of all preventive programs, funded by GAVI/GFATM

The Ministry coordinates with the World Health Organisation (WHO), Provincial and District Health Authorities, to prevent, detect, and respond to epidemics and pandemics.

---

<sup>15</sup> [www.ispr.gov.pk](http://www.ispr.gov.pk)

## National Health Emergency Preparedness Network (NHEPRN)

NHEPRN has been assigned the role of Disaster Risk Management in the Health Sector and is responsible for all aspects of health-related emergency management including Preparedness, Response and Recovery. NHEPRN operates under the Ministry of Health Services, Regulation and Coordination, and supports the health components of disaster response with NDMA.

## Ministry of Food Security and Research – Animal Quarantine Department (AQD)

The Animal Quarantine Department (AQD)<sup>16</sup> is responsible for:

- Regulating the import, export and quarantine of animals and animal products, in order to prevent introduction or spread of exotic diseases
- Maintaining quarantine services of high standards, to protect the livestock industry of Pakistan and other countries
- Providing certification services to the exporters and importers
- Data on livestock numbers

**NOTE 2: Provincial Governments also have Livestock Departments which should also be contacted for technical support on potential diseases.**

**NOTE 1: For Search and Rescue (SAR) Teams: The AQD should be contacted in relation to the import of Search and Rescue Animals to ensure that their certification is current and clearance processes are in order to ensure rapid deployment.**

## Survey of Pakistan - Mapping

The Survey of Pakistan is the authority responsible for mapping activities in Pakistan.<sup>17</sup> **In the event of a disaster, foreign and other responders should note that it is only Survey of Pakistan and approved organisations that are authorised to conduct surveying and mapping activities in Pakistan.**<sup>18</sup> For information in relation to acquiring maps during a disaster, contact should be made with NDMA.

## Funding Appeals

The **Government of Pakistan may**, if a disaster is of sufficient proportions, launch an international appeal for funds from foreign donors. The decision will be taken by the Prime Minister of Pakistan in consultation with the Economic Affairs Division (EAD), Ministry of Foreign Affairs (MOFA), NDMA, and other relevant Government authorities and stakeholders.

**NOTE: Hydrographer, Pakistan Navy is the authority which conducts the surveys of coastal areas of Pakistan.**

## Provincial Disaster Management Authorities

In 2010, responsibility for Disaster Management was formally devolved to the Provinces though the actual devolution took place earlier in the National Disaster Management Ordinance 2007. While NDMA is the key National Authority, at a Provincial level, the **Provincial Disaster Management**

<sup>16</sup> <http://202.83.164.29/mnfsr/frmDetails.aspx?opt=misclinks&id=22>

<sup>17</sup> <http://www.surveyofpakistan.gov.pk/>

<sup>18</sup> The Surveying and Mapping Act 2014 and the Surveying and Mapping Rules 2015 provide information on the rules and the penalties related to the Act.

**Authorities (PDMAs)** are responsible for response, while the District **Disaster Management Authorities (DDMAs)** works at District level coordinating with the Provincial and National authorities. The PDMAs have similar responsibilities within their Province/Region to manage the response and coordinate with NDMA.

PDMAs act as the implementing, coordinating, and monitoring body for disaster management in a province/region. The various authorities as are:

- PDMA Balochistan
- PDMA Khyber Pakhtunkhwa (KP)
- PDMA Punjab
- PDMA Sindh
- SDMA - State Disaster Management Authority Azad Jammu & Kashmir
- GBDMA - Gilgit Baltistan Disaster Management Authority
- FDMA - Federally Administered Tribal Areas (FATA) Disaster Management Authority. FDMA (may be subsumed into PDMA Khyber Pakhtunkhwa in the merger process of FATA into KP)

The PDMAs play a vital role in response and in managing the relief activities, implementing and coordinating at provincial level with all stakeholders including the affected communities. PDMAs have their own individual disaster management and response procedures in addition to national coordination mechanisms. In the event of a large-scale disaster requiring foreign assistance, NDMA coordinates with the PDMAs to support ‘on-the-ground’ response activities to ensure a smooth distribution of assistance from foreign responders.

Under the technical guidance of NDMA, the PDMAs prepare disaster management plans for all types of disasters in accordance with NDMA guidelines. PDMAs also coordinate the response in the event of any threatening disaster situation or actual disaster. Provincial Emergency Operations Centres (PEOCs) are operational 24/7 throughout the year. They supervise and coordinate relief and rescue operations for the entire province. PDMAs also prepare regular situation updates and briefings to share with all stakeholders and NDMA. Briefs and presentations are prepared for Chief Minister, Chief Secretary, concerned Minister, the Provincial Assembly, and other dignitaries in the province.

PDMAs also coordinate with field formations and other formations of the Pakistan Army, and coordinate with line departments/agencies and humanitarian organisations. As part of their annual contingency planning and preparedness activities for the monsoon season, PDMAs, with inputs from DDMAs, conduct needs and gap analyses of relief goods and stock their warehouses with necessary relief items based on previous disasters. In addition, lists of community-based volunteers for disaster preparedness in vulnerable communities are prepared.

In the immediate aftermath of a disaster, PDMAs coordinate the process of conducting needs assessments in their jurisdiction in coordination with all stakeholders. The following thematic areas may be covered:

- Food
- Shelter
- Essential items such as bedding blankets, heaters, water containers

- Household items
- Medical and other health items
- Safe drinking water
- Water and sanitation
- Waste disposal
- Boats, outboard motors, life jackets
- Dewatering of affected households
- Damaged infrastructure
- Psychosocial support

**NOTE: PDMA's will most likely host foreign responders during the emergency phase. All responding organisations may also be required to sign an MOU with the relevant PDMA encompassing proposed activities. Humanitarian agencies mobilizing to any of the PDMA's provinces/regions must first undergo verification and clearances from the Ministry of Foreign Affairs (MOFA) and Ministry of Interior (MOI) to ensure smooth response in all areas.**

To assist the overall process, PDMA's and their District Authorities prepare and share with NDMA the following:

- Roster of Volunteers - F/G/S/PDMA's and DDMA's as well as relevant agencies shall prepare the rosters for volunteers and CBO to support the assessment and rescue/relief activities in the affected areas.
- List of Relief Goods – PDMA's and DDMA's shall prepare a list of necessary relief goods and disclose its contents based on the assessment results in the past flood and sediment disasters prior to the occurrence of disasters.
- List of Donations to be accepted –F/S/PDMA's and DDMA's shall prepare the list of donations to be accepted and the procedure for use of donations in advance.

## Provincial Emergency Services

Some provinces also have provincial emergency services which will engage in disaster response.

### *Rescue 1122*

Rescue 1122 is a rescue service initially established in Punjab Province through Punjab Emergency Services Act. The service in Punjab covers all districts. Through the technical assistance of Rescue 1122 Punjab, the service has also been established in Balochistan, Khyber Pakhtunkhwa, Azad Jammu & Kashmir and Gilgit Baltistan. This essential service has rescued millions of victims through its ambulance, fire and rescue teams.

## Pakistan Armed Forces

The Pakistan Armed Forces (Army, Navy Air Force,) play a leading role in disaster response and relief in Pakistan. On request from the Government, all arms of the military may be called upon to provide response, including rescue and relief in the event of any disaster, large or small. In the 2010 Super Floods, the Pakistan Armed Forces deployed over 100,000 personnel to assist affected communities.

In addition to the Military, civil armed forces such as the Pakistan Rangers, Frontier Corps, Frontier Constabulary, the Coast Guard, Civil Defence, (under the mandate and responsibility of the Ministry of Interior) and PMSA (under MoD), also participate in disaster response where necessary.

The Pakistan Armed Forces are extremely experienced and capable in disaster response and also in reconstruction and rehabilitation in the later stages. The military has its own extensive SOPs for disaster response and is able to mobilise immediately across the country providing an extensive operation which can include rescue and relief, logistics, aviation, airport/aviation management and coordination, medical teams and field hospitals, food, boats, trucks, equipment, personnel, communications, engineers, communications, coordination and security.

Should the assistance of foreign militaries be requested or offered, Joint Services Headquarters (JSHQ) in coordination with each arm of the military, will make the decisions on the precise requirements, ROEs, and rules for participation and coordination. Following a decision to accept assistance from any foreign military, JSHQ and various arms of the military will host foreign military contingents and their assets to ensure effective and appropriate participation, safety and security.

## Foreign Militaries

In previous disasters, a number of countries have provided military assistance comprising personnel, aviation assets, field hospitals and medical teams, and relief items to support Pakistan. Each foreign military team worked in coordination with and under the direction of the Pakistan military in the field to ensure common operating picture, proper support, safety and security.

To assist foreign militaries which anticipate deploying military contingents and assets to Pakistan, and for the clarity of all stakeholders, **in consultation with the JSHQ, MOFA and NDMA**, the following information should be provided through official channels to all services and stakeholders:

- SOPs, ROEs, procedures, rules, responsibilities and coordination points
- Clear definition of the roles and responsibilities of all parties to manage expectations and handover procedures

- Personnel data and qualifications are required
- The need for foreign militaries need to come prepared with own equipment
- Restrictions on weapons
- Safety pilots on all foreign aircraft will be mandatory and imperative
- Advice on all aspects of operations from the local military commanders must be followed
- Foreign Armed Forces providing aviation assets should ensure participation in the Joint Aviation Coordination Cell.
- Foreign Military contingents will be centralized under an NDMA coordination and monitoring cell in particular zones.
- Foreign Military should coordinate with their Host Military Formations for any contact with the PDMAs.
- Restrictions on dual purpose technical equipment will be defined by relevant stakeholders.
- Weapons of any kind are prohibited from being brought into the country.
- Security clearances for all Foreign Humanitarian Organisations and Military Contingents must be sought from relevant authorities prior to deployment.
- Foreign Military Contingents operating in the field should not have direct or unescorted interaction with the local population. Armed Forces personnel should accompany as local liaison.

## Joint Aviation Coordination Cell (JACC)

A Joint Aviation Coordination Cell (JACC) will be immediately established by NDMA with support of JSHQ to control the airport relief traffic. The JACC brings together representatives from Civil Aviation Authority, Pakistan Army Aviation, Pakistan Air Force, Navy Aviation, Military Operations Directorate (MO Dte), GHQ, NDMA, representatives of PDMAs, foreign militaries and UN agencies including World Food Program (WFP) and UNHAS.

The need for a JACC was a Lesson Learned from the 2005 earthquake relief operations and again proved to be very effective in the 2010 floods in optimizing smooth coordination and utilisation of available aviation assets to provide timely rescue and relief to the affected communities.

The JACC will have representation from all three services – Army, Navy and Air Force – especially those providing assets for air relief effort. Moreover, two sub-organisations may be formed under JACC as under:

1. Establishment of Air Coordination Centre (ACC) to coordinate air traffic that is bringing relief goods, equipment and personnel from donor countries to main airports/airfields.
2. Establishment of Aviation Operations Control Centre (AOCC) to coordinate air traffic related to rescue and relief operations within the country. Army Aviation may be given the lead role in AOCC as it is the major stakeholder, operator of the main fleet and having more knowledge of layout and requirements of various disaster-prone regions. (see organogram below)



## Pakistan Air Force - Air Headquarters, Islamabad

To support the response, Air Headquarters of the Pakistan Air Force contributes the following:

1. Rotary and fixed wing assets remain prepared for extending support in all phases in the aftermath of any national calamity. The assets may be mobilised for any emergent requirement on the intimation by NDMA.
2. In the aftermath of any large-scale disaster, necessary communication facilities will be provided to foreign missions arriving in Pakistan, upon receipt of instructions from competent authority.
3. Provisioning of military clearance to foreign military aircraft over-flying or landing to/from Pakistan territory as per MoD procedure through diplomatic channels.
4. Establishment of ATC for rescue/relief flying operations in affected areas.
5. Formulation of temporary airspace management procedures, if required and air traffic coordination/arrangement for safe relief operations
6. Coordination with Civil and Military LEAs for smooth conduct of relief operations from PAF Bases.
7. Establishment of medical camps along with para-medical staff and provisioning of efficient medical support in disaster-hit areas through prompt response within a short and compressed time frame.
8. Role and Task of PAF transport fleet for quick and reactive emergency response:
  - Provision of air ambulance service
  - Evacuation of injured personnel/seriously affected populace
  - Aerial drop of edibles and equipment
  - Air transportation of relief goods and affected populace
  - Aerial survey of affected areas
  - VVIP/VIP visits to affected areas using PAF aircraft.

# Organisation of Joint Air Coordination Cell (JACC)

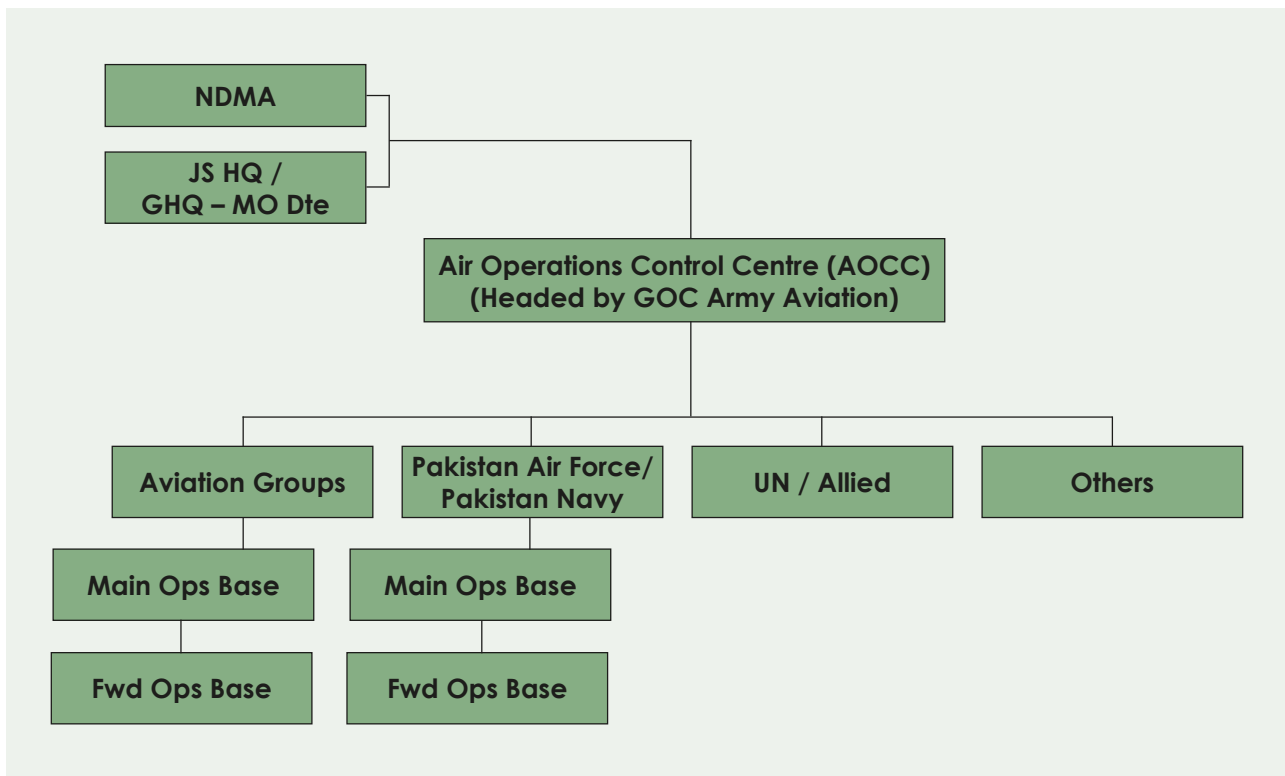

## *UN and Humanitarian Organisations*

UN and other humanitarian agencies providing aviation assistance should in the first instance coordinate with NDMA who in turn with liaison with JSHQ, to facilitate participation in a JACC.

## *Civil-Military Coordination with Humanitarian Community (CMCoord)*

For Civil-Military Coordination (CMCoord) with the humanitarian agencies, the military coordinates with National Disaster Management Authority (NDMA). The military do not generally coordinate directly with the humanitarian organisations though at times they may participate in coordination meetings organized by NDMA for all key stakeholders.

The military formations may also direct activities in the field to ensure safety and security and compliance with local restrictions. Any instructions from Government, law enforcement agencies or military to humanitarian groups in the field must be followed.

**Note: A Joint Aviation Coordination Cell could also play an important role in other types of disasters including massive wild fires where foreign specially-equipped fire-fighting aviation assets may need to be deployed to support local capacity, as is often seen in other countries. NDMA should be contacted for coordination arrangements in the event of such disasters**

## Section

# 7

## Guide for Assisting Countries & Humanitarian Community

### Prepare/Get Ready

- Monitor the situation, communicate, and prepare to assist
- Commence early planning for assistance and deployments
- Check with NDMA and relevant authorities for simplified customs, immigration and quarantine procedures in the event of a deployment
- Notify and prepare personnel

### Special Policies – INGOs

- Review Ministry of Interior website <https://ingo.interior.gov.pk/> to understand and comply with the latest policies for INGO operations in Pakistan and whether the organisation will require registration before proceeding
- Identify what assistance is required
- Identify local partners
- Provide specific offer of assistance
- Apply for Visas at Pakistan Embassy or High Commission in home country
- Obtain No Objection Certificate (NOC) to operate in Pakistan
- Obtain No Objection Certificate (NOC) to operate in specific affected area

### Initiate

- A Point of Contact in all Donor Missions
- Review all communications from Pakistan Government authorities
- Consult all existing Standard Operating Procedures and Guidelines

- Make a formal offer of disaster response or respond to a request for disaster response
- Initiate processes to obtain necessary visas, permits and clearances for Pakistan
- Activate simplified customs, immigration and quarantine procedures
- Provide lists of disaster response goods intended for shipment to Pakistan, to NDMA and Customs approval
- Provide lists of incoming personnel and details of their qualifications or registrations for any necessary clearances

## Responding to Needs

- NDMA and the Government of Pakistan will provide a list of required items, not available in the country at the time of the disaster. This will be notified to the Ministry of Foreign Affairs for dissemination to all Pakistan embassies overseas, and to foreign embassies in Pakistan.
- Receiving of Relief Assistance is managed by NDMA on behalf of Government of Pakistan. For full information please refer to *NDMA website for Guidelines on Stocking, Maintenance and Supply of Relief & Rescue Items*.<sup>19</sup>
- The following information must be supplied to NDMA:
  - Receipt of offer by donating countries through MoFA and Economic Affairs Division (EAD) after acceptance approval by Government of Pakistan.
  - Details of a contact/focal person. Details to be forwarded to donor country through MoFA and EAD.
  - Input from MoFA and EAD on following:
    - Details of donation, including quantity.
    - Mode of transportation and disembarkation sea/air port.
    - Time frame.
    - Any other information as may be required.
  - Contact person of donating country at their embassy at Islamabad.
  - Coordination with Armed Forces CAA, PIA, Customs and other relevant authorities.
  - Media coverage for receiving ceremony.
  - Arranging letters from CBR for exemption of taxes and duties by Government of Pakistan.
  - Hiring of Custom Clearing Agent before arrival of donation.
  - If donation is to be delivered by sea then coordination and arrangement of transport of donated goods from Karachi/Bin Qasim port to NDMA warehouse will be undertaken.
  - If the donation is to be delivered by air then coordination with airport cargo handling agencies for waiving of service charges will be undertaken.

---

<sup>19</sup> NDMA Guidelines on Stocking, Maintenance and Supply of Relief & Rescue Items  
<http://www.ndma.gov.pk/publications/NDMA-Guidelines.pdf>

## Country Entry Requirements

- **Customs - Customs Wing of the Federal Board of Revenue** is responsible for all matters related to the entry of all goods into Pakistan.
- **Visa/Immigration** - Contact Pakistan Mission in home country to make visa applications and apply for clearances.
- **Search and Rescue Animals** - Animal Quarantine Department to arrange immediate clearance provided the appropriate health documents are provided on landing. Search and Rescue teams must ensure they are carrying the correct documents.
- Provide accreditation documentation for disaster response personnel to NDMA and relevant Ministries or Departments as requested
- **ICT Equipment** - If any responding organisation – civilian or military – intends to bring ICT equipment into Pakistan, it must first be cleared through the Pakistan Telecommunications Authority (PTA) and Customs Wing. (Please refer to PTA and Customs details in “Section 3 – Government Stakeholders)
- Ensure ability to comply with minimum standards of quality in relation to all forms of assistance
- Check health and safety, immunity and indemnity requirements and procedures
- Ensure response teams will be self-sufficient and not be an additional burden on local resources.
- Prepare to ‘buy local’ where possible to ensure support and recovery of local economies.

Unsolicited relief items are problematic in times of disasters and costly for the affected country. In past disasters, Pakistan has received many containers of goods that are deemed inappropriate to the needs, out-of-date medicines, non-Halal packaged foods, clothing not culturally suitable for Pakistan or the affected areas, and consignments which do not have a designated receiver. No unsolicited relief items should be accepted.

## Arrival

- Upon arrival of International NGOs and other humanitarian responders in Pakistan, a detailed briefing encompassing area orientation, rules and obligations, and cultural aspects will be provided by NDMA and other relevant officials.
- All briefings will include a briefing on the diverse cultures, customs, and religious beliefs of the nation and the designated areas of operation before proceeding with response activities. These must be respected.
- All response teams must provide and carry all required documentation including copies of passports, visas, No-Objection Certifications (NOCs), qualifications (particularly for medical teams), and other as required.
- Respect the sovereignty of Pakistan in all matters
- Respect local customs, religion and culture at all times
- Where possible, source relief goods locally
- Respect and obey all directions as issued by NDMA, provincial and district authorities, and the Armed Forces in the field

## Coordination

- Foreign Humanitarian Organisations must coordinate with the NDMA Coordination Cell in relation to all matters of relief.

- Monitor and report progress to NDMA during response
- All humanitarian actors may work **only** in the sectors and geographic areas identified, prioritized and authorised by the Government of Pakistan through NDMA.
- Foreign Humanitarian Organisations operating in the field should not interact with the local population unless approved and accompanied by Government and/or Armed Forces personnel.

## Cluster Management

- UN Cluster System, if initiated, should ensure its capacity in information management to assist in efficiently managing the humanitarian response through information sharing. Duplication of effort should be avoided and an integrated plan should be developed at the outset for all stages of relief work, i.e. from assessments to the delivery of services and shared with NDMA.
- Clusters should be activated to function in line with NDMA and PDMA organizational structures at the federal and provincial levels in order to achieve greater coherence between the humanitarian community and government.
- Special efforts must be undertaken by cluster chairs to reach out towards local organizations with roots in disaster prone areas to bring them under the cluster umbrella.
- The number of clusters to be deployed should be focused on priority sectors and approved by NDMA.
- Cluster coordination needs to be accessible, location-wise, to government functionaries at the provincial and district level.
- A standard monitoring system needs to be applied across clusters and training in reporting needs to take place at federal, provincial and district levels for NGOs and government staff. A system for ensuring compliance also requires development, with requisite legal provisions inbuilt into the cluster system.
- Clusters, in coordination with donors, need to help further develop the capacity of local NGOs to utilise resources effectively in disaster situations but including those that have core capabilities and experience.
- In order to overcome language barriers, bilingualism should be encouraged in cluster communication, especially at the provincial and hub level.
- All stakeholders must ensure adherence to principles of gender equality through mainstreaming gender and acknowledging the differentiated needs, concerns, priorities and capacities, as well as the contributions of women, girls, men and boys in the process of disaster preparedness and response. Reporting must be conducted by disaggregating data along gender and child/adult lines

## Exit and Handing Over

- The Government of Pakistan will decide when national capacity is again able to handle the situation. NDMA will advise all foreign responders on behalf of the Government, of the final date for response, handing over, and for departing the country.
- Gifting of medical and other equipment should be formally handed over to the Government of Pakistan for distribution to suitable Government facilities (hospitals etc), and in line with any arrangements with the Customs Wing when the equipment was imported.
- Before departure, all foreign responders should provide a report on their activities, status of the affected community, financial contributions, and other information as required by the Government of Pakistan through NDMA.

## Section

# 8

## Guidance for Foreign Responders

### Assisting Countries

Pakistan has always been appreciative of the assistance of foreign countries and organisations at times when national capacity becomes overwhelmed. Many lessons were learned from previous disasters in managing the many challenges that can arise with an influx of foreign responders.

The type of assistance may vary according to the bilateral relationships, the needs, and the capacity of an assisting country. Some countries which respond to disasters overseas, have moved to an integrated or multi-agency approach.

### Integrated/Multi-Agency Missions

Integrated or Multi-Agency teams could include civilian/military medical teams, and other specialists, military personnel, field hospitals, relief goods, and aviation assets. Integrated missions are usually organised at a bilateral level through the relevant Ministries and Departments, including Foreign Affairs, EAD, and Defence, and in coordination with NDMA. Integrated missions are a more manageable option for the host country as it streamlines the many coordination processes and ensures a more effective response in line with Pakistan's requirements.

#### *Case Study: Australian Medical Task Force – Pakistan 2010 Floods*

In response to the 2010 floods in Pakistan, the Government of Australia deployed Australian Medical Task Force (AMTF) a multi-agency (or Whole-of-Government) team to assist. The AMTF was deployed at Kot Addu and worked in close coordination with the Pakistan Army. The location of the AMTF was determined by the Pakistan military, based on needs in the area. Comprising approximately 180 AusAID (now part of DFAT), Defence and civilian doctors, nurses, paramedics and support personnel from state and federal government departments, the Australian Medical Task Force treated over 11,000 people with primary medical care, assisted in the rebuilding of a local school, provided over 3,000 families with essential relief items and supplied 1.2 million litres of purified water.

The AMTF attributed the smooth operations of the medical assistance to the support, friendly assistance, and security, provided by the Pakistan Army. They appreciated the coordination with NDMA. In addition to the AMTF, the Government of Australia provided an additional \$50 million in response funding to UN and humanitarian organisations, and further funding contributions to the early recovery process.

The Australian Government, through various organisations including both civil and military, continues to conduct exercises multi-agency exercises and training in preparation for any future response in the Asia-Pacific region.

The United States of America and the United Kingdom also have policies of multi-agency response in disasters were it will prove to me more effective. In the 2010 floods, the US provided both military and civilian response coordinated through the Office of US Disaster Assistance (OFDA).<sup>20</sup> The US military provided 28 helicopters and other aviation assets to support the Pakistan military’s humanitarian activities. OFDA sends regional and technical experts to the affected country to identify and prioritise humanitarian needs.

In the wake of a large-scale disaster, OFDA can deploy a Disaster Assistance Response Team (DART) to coordinate and manage an optimal U.S. Government response, while working closely with local officials, the international community, and relief agencies. OFDA also maintains stocks of emergency relief supplies in warehouses worldwide and has the logistical and operational capabilities to deliver them quickly.

China, Turkey, UAE, Japan, UK, EU, and Italy, have also generously provided a range of assistance including field hospitals, aviation assets and other support to Pakistan in large-scale disasters. Each has their own bilateral arrangements with Pakistan and internal process for how to respond when disasters strike.

The Government of Pakistan has signed, or is in the process of developing bilateral MOUs in the field of disaster management with the following countries:

- Afghanistan (Under Process)
- Azerbaijan
- China
- Cuba
- Kazakhstan (Under Process)
- Republic of Korea
- Kyrgyzstan
- SAARC Countries - Rapid Response Agreement (signed 2011)
- Sri Lanka.
- Turkey

---

<sup>20</sup> Office of US Disaster Assistance (OFDA). <https://www.usaid.gov/who-we-are/organization/bureaus/bureau-democracy-conflict-and-humanitarian-assistance/office-us>



# Humanitarian Community

## United Nations

The United Nations is normally a substantial responder in disasters, when requested by a host government. The UN agencies most usually involved are:

- UN Resident /Humanitarian Coordinator (RC/HC)
- Office of the Coordination of Humanitarian Affairs (OCHA)
- World Food Programme (WFP)
- World Health Organisation (WHO)
- United Nations Children’s Fund (UNICEF)
- United Nations Entity for Gender Equality and the Empowerment of Women (UNWOMEN)
- United Nations Human Settlements Programme (UN-HABITAT)
- United Nations Development Programme (UNDP)
- Food and Agriculture Organisation of the United Nations (FAO)
- International Organisation for Migration (IOM)
- United Nations High Commissioner for Refugees (UNHCR)

The United Nations plays an important role in disaster response globally and has done so, on many occasions in Pakistan. Various UN agencies support the host country to respond to, and manage, the humanitarian response depending on the requirements of the government.

The coordination structure in Pakistan consists of the Resident/Humanitarian Coordinator, UNOCHA, the Humanitarian Country Team (HCT), the inter-cluster coordination mechanism at national and provincial levels, and district coordination cells, in affected areas. The HC leads the HCT, which comprises UN humanitarian agencies and international NGO (INGO) and national NGOs representatives, with IFRC and ICRC as observers.

### ***UN Resident Coordinator (UNRC)***

The Resident Coordinator (RC) system encompasses all organisations of the United Nations system dealing with operational activities for development, regardless of their formal presence in the country. The RC system aims to bring together the different UN agencies to improve the efficiency and effectiveness of operational activities at the country level.

In Pakistan, the UN RC is the representative of the Secretary-General for the UN system. As the chair of the UN Country Team (UNCT), comprising the head of all UN Agencies, Funds and Programmes, and as such plays a central role at the country level in making possible the coordination of UN operational activities for development in order to ensure alignment of UN assistance with national development priorities, plans and capacity building in the context of internationally agreed treaty obligations and development goals, and placing the UN centrally in development and international cooperation in the country.

## **UNOCHA**

The United Nations Office for the Coordination of Humanitarian Affairs (UNOCHA) brings together humanitarian actors to ensure a coherent response to emergencies in Pakistan, and to establish a framework within which each actor can contribute to the overall response effort. OCHA's core functions, such as operational coordination, humanitarian financing, advocacy and information management, in response to humanitarian needs.

### ***United Nations Disaster Assessment and Coordination (UNDAC)***

The United Nations Disaster Assessment and Coordination (UNDAC) is part of the international emergency response system for sudden-onset emergencies. IFRC frequently participates in UNDAC missions. It is designed to help the United Nations and governments of disaster-affected countries during the first phase of a sudden-onset emergency. UNDAC also assists in the coordination of incoming international relief at national level and/or at the site of the emergency.

The UNDAC team was established in 1993 and today consists of more than 250 national emergency managers from more than 70 member and participating countries, together with staff from OCHA and 16 international and regional organizations including UN agencies.

UNDAC teams can deploy at short notice (12-48 hours) anywhere in the world. **They are provided free of charge to the disaster-affected country**, and deployed upon the request of the United Nations Resident or Humanitarian Coordinator and/or the affected Government.

Assessment, coordination and information management are UNDAC's core mandates in an emergency response mission. Specifically in response to earthquakes, UNDAC teams set up and manage the On-Site Operations Coordination Centre (OSOCC) to help coordinate international Urban Search and Rescue (USAR) teams responding to the disaster - essential if USAR assistance is to function effectively.

UNDAC member countries are those countries that financially support their participation in the UNDAC system through depositing funds with OCHA (in so-called "mission accounts") to cover the deployment costs of their national UNDAC members on UNDAC mission. In addition to countries, the UNDAC system counts on the participation of the following organisations: ECHO & Civil Protection Mechanism, CEPREDENAC, ASEAN, ECOWAS, IFRC, ISDR, OCHA, UNDP, UN-DSS, UNEP, UNICEF, UNOSAT, WFP, World Bank, WHO & PAHO. This provides all organisations an immediate assessment of the situation.

### ***Inter-Agency Standing Committee (IASC)***

The Inter-Agency Standing Committee (IASC) is the primary mechanism for inter-agency coordination of humanitarian assistance. It is a unique forum involving the key UN and non-UN humanitarian partners. The IASC was established in June 1992 in response to United Nations General Assembly Resolution 46/182 on the strengthening of humanitarian assistance.

The members of the IASC are the heads or their designated representatives of the UN operational agencies (UNDP, UNICEF, UNHCR, WFP, FAO, WHO, UN-HABITAT, OCHA). In addition, there is a standing invitation to IOM, ICRC, IFRC, OHCHR, UNFPA, the Special Rapporteur on the Human Rights of IDPs and the World Bank. The NGO consortia ICVA, InterAction and SCHR are also invited on a permanent basis to attend. The IASC is chaired by the ERC. IASC provides Operation Guidelines on the Protection of Persons in Situations of Natural Disasters.<sup>21</sup>

---

<sup>21</sup> IASC. 2011. Operational Guidelines on the Protection of Persons in Situations of Natural Disasters [http://www.ohchr.org/Documents/Issues/IDPersons/OperationalGuidelines\\_IDP.pdf](http://www.ohchr.org/Documents/Issues/IDPersons/OperationalGuidelines_IDP.pdf)

### *International Search and Rescue Advisory Group (INSARAG)*

The International Search and Rescue Advisory Group (INSARAG)<sup>22</sup> is a network of disaster-prone and disaster-responding countries and organisations dedicated to urban search and rescue (USAR) and operational field coordination. INSARAG was established in 1991 following initiatives of international SAR teams that responded to the 1988 Armenia earthquake. The United Nations was chosen as the INSARAG secretariat to facilitate international participation and coordination. The Field Coordination Support Section (FCSS), located within OCHA Geneva's Emergency Services Branch (ESB), functions as the INSARAG secretariat. INSARAG is mandated to:

- Render emergency preparedness and response activities more effective and thereby save more lives, reduce suffering and minimise adverse consequences.
- Improve efficiency in cooperation among international SAR teams working in collapsed structures at a disaster site.
- Promote activities designed to improve search-and-rescue preparedness in disaster-prone countries, thereby prioritising developing countries.
- Develop internationally accepted procedures and systems for sustained cooperation between national SAR teams operating on the international scene.
- Develop SAR procedures, guidelines and best practices, and strengthen cooperation between interested organizations during the emergency relief phase.

### *On-Site Operations Coordination Centre (OSOCC)*

The On-Site Operations Coordination Centre (OSOCC)<sup>23</sup> is a rapid response tool that provides a platform for the coordination of international response activities in the immediate aftermath of a sudden onset emergency. It is at the same time both a methodology and a physical location for on-site emergency response coordination. The OSOCC is designed to work in support of the Government of the affected country and is a tool for the United Nations Office for the Coordination of Humanitarian Affairs (OCHA) to carry out its mandate of coordination and information management in emergency response, particularly at the field level.

The nature of the OSOCC enables the concept to be utilised by other organizations when responding to emergencies, including international response organizations and Governments. OSOCC Guidelines are intended for use by organizations or response teams who may be establishing and managing an OSOCC (e.g., United Nations Disaster Assessment and Coordination [UNDAC] teams), organizations or teams who may work within an OSOCC (e.g., Urban Search and Rescue [USAR] teams, Foreign Medical Teams [FMTs], Cluster Coordinators), and organizations who may interact with an OSOCC (e.g., Government of a requesting country, Local Emergency Management Authority [LEMA], Cluster Coordinators). The OSOCC Guidelines may also be used and adapted by national or local emergency management authorities for on-site coordination of emergency responses.

### *Cluster System*

Clusters are groups of humanitarian organizations (UN and non-UN) working in the main sectors of humanitarian action, e.g. shelter and health. They are created when clear humanitarian needs exist within a sector, when there are numerous actors within sectors and when national authorities need

---

<sup>22</sup> UNOCHA. INSARAG. <http://www.unocha.org/what-we-do/coordination-tools/insarag/overview>

<sup>23</sup> UNOCHA. OSOCC Guidelines 2014. <http://www.unocha.org/what-we-do/coordination-tools/osoccc-rdc/overview>

coordination support. Clusters provide a clear point of contact and are accountable for adequate and appropriate humanitarian assistance. Clusters create partnerships between international humanitarian actors, cluster lead agencies and NGOs to develop policies, coordinate inter-cluster issues, disseminate operational guidance and organise field support.

In the event of a major disaster, the Cluster System may be mobilised at the request of the Government of Pakistan and in consultation with NDMA, to assist with certain sectors of the response. The number of Clusters, and their leadership, may vary according to local needs and existing presence of organisations.

Cluster	Lead Agency
Humanitarian & Emergency Relief Coordination	UNOCHA
WASH	UNICEF
Food Security	FAO, WFP
Health	WHO
Nutrition	UNICEF
Emergency Telecommunications	WFP
Emergency Shelter	UNHCR
Logistics	WFP
Education	UNICEF
Camp Management & Coordination	UNHCR
IOM	
Protection	UNHCR, IOM
Community Restoration	UNDP
Humanitarian Communication	IOM

## International Red Cross and Red Crescent Movement

The International Red Cross and Red Crescent Movement is the world’s largest humanitarian network. The Movement is neutral and impartial, and provides protection and assistance to people affected by disasters and conflicts. The national office also serves as a base for other Red Cross/Red Crescent national bodies from foreign countries that deploy to provide additional support in large-scale disasters. All aspects of the work of the Red Cross and Red Crescent Movement, including disaster response, are guided by their own organisational principles and guidelines.<sup>24</sup> The national office also serves as a base for other Red Cross/Red Crescent national bodies from foreign countries that deploy to provide additional support in large-scale disasters.

### *International Committee of the Red Cross and Red Crescent (ICRC)*

The International Committee of the Red Cross (ICRC) is an impartial, neutral and independent organization whose exclusively humanitarian mission is to protect the lives and dignity of victims of war and internal violence and to provide them with assistance. During situations of conflict, the ICRC is responsible for directing and coordinating the Movement’s international relief activities. It also promotes the importance of international humanitarian law and draws attention to universal

<sup>24</sup> IFRC. <http://www.ifrc.org/en/what-we-do/disaster-management/about-disaster-management/>

humanitarian principles. As the custodian of the Geneva Conventions, the ICRC has a permanent mandate under international law to visit prisons, organise relief operations, reunite separated families and undertake other humanitarian activities during armed conflicts.<sup>25</sup>

### ***The Pakistan Red Crescent Society (PRCS)***

The Pakistan Red Crescent Society (PRCS) has been active in all major disasters since its inception in 1947. With a volunteer base of 1.5 million, along with the staff of the organisation, PRCS is able to provide a wide range of humanitarian activities in disaster response. PRCS has branches in seven Provinces and 92 Districts of Pakistan and is able to mobilise rapidly. The national office also serves as a base for Red Cross/Red Crescent national bodies from foreign countries that deploy to Pakistan to provide additional support in large-scale disasters.

## **International and National Non-Government Organisations (INGOs and NGOs)**

International and national Non-Government Organisations (I/NGO) may be invited to assist according to their core capacities. The INGO sector in Pakistan is regulated by the **Ministry of Interior** which has established clear policies on the operation of INGOs. **Full details are available on the INGO section of MOI website <https://ingo.interior.gov.pk/>.**

### **INGO Policy and Rules**

INGOs are regulated through the **Ministry of Interior (MOI)** and must have approval and an MOU with the Government to operate in Pakistan (for further details see section on Ministry of Interior). As indicated in the INGO Policy, at the discretion of the Minister, non-registered INGOs may be granted permission to assist on disaster response for a period of up to six months subject to meeting certain criteria.

Before any visit or deployment to Pakistan in the event of a disaster, the policies of the MOI must be well understood. INGOs and other humanitarian organisations must first check with MOI and/or through the Pakistan Embassy in their home country as to the requirements for visas and authority to participate in the response as INGOs are subject to a specific policy.

In 2015, Pakistan's Ministry of Interior implemented a new registration policy for all INGOs and other organisations which operate in Pakistan and/or receive foreign funding.<sup>26</sup> The policy regulates the registration, working, funding, monitoring and other related aspects pertaining to all types of International Non-Governmental Organizations (INGOs) functioning in Pakistan. No INGO is permitted to work in Pakistan without registration through the Ministry of Interior. The process requires substantial documentation and the approvals of a number of other government agencies.

There is a provision in the policy (clause 7.4) special consideration may be given to exempt an INGO in the event of a major calamity. *“If the Government may deem it in public interest (such as in situations of national disasters and other calamities), it may, subject to such conditions that it may specify, exempt an INGO from all or any of the provisions of this policy for a period not exceeding 6 months.”*

**No-Objection Certificates (NOCs) from Government authorities are required to operate in Pakistan, in affected areas, and for movement of personnel to certain areas.**

<sup>25</sup> ICRC. <http://www.ifrc.org/en/who-we-are/the-movement/icrc/>

<sup>26</sup> Government of Pakistan. Ministry of Interior. 2015. Policy for regulation of International Non-governmental Organizations (INGOs) in Pakistan. <https://ingo.interior.gov.pk/>

### ***Pakistan Humanitarian Forum (PHF)***

The Pakistan Humanitarian Forum (PHF)<sup>27</sup> is an independent coordinating forum that supports and facilitates the work of INGOs to effectively address the humanitarian and development needs across Pakistan. All PHF members are required to sign and adhere to the PHF code of conduct and in doing so commit to providing humanitarian and/or development assistance to the people of Pakistan based on need alone regardless of nationality, gender, background, political affiliations, or religious beliefs. PHF is a valuable contact point for INGOs working in, or planning to work in Pakistan to get a full understanding of the requirements.

## **Pakistan Humanitarian Organisations and Networks**

For foreign responders requiring information on appropriate partner organisations in Pakistan, there are a number of umbrella organisations for international and national NGOs, and other respected humanitarian organisations which are useful points of contact. These include (but are not limited to):

### ***Edhi Foundation***

The Edhi Foundation is a highly respected non-profit social welfare program in Pakistan, founded by the late Abdul Sattar Edhi in 1951. Headquartered in Karachi, the Edhi Foundation provides 24-hour emergency assistance across Pakistan. The Foundation provides, among many other services, shelter for the destitute, free hospitals and medical care, drug rehabilitation services, and national and international relief efforts. Its main focuses are Emergency Services, Orphans, Handicapped Persons, Shelters, Education, Healthcare, International Community Centers, Blood & Drug Bank, air ambulance services, Marine and Coastal Services. The Edhi Foundation is one of the first local responders in all types of emergencies.

### ***Rural Support Programmes Network (RSPN)***

The Rural Support Programmes Network (RSPN)<sup>28</sup> consists of eleven member Rural Support Programmes (RSPs) that espouse a common approach to rural development: social mobilisation. The RSPs provide social guidance, and technical and financial assistance to the rural poor. RSPN provides capacity building support to RSPs, and assists them in policy advocacy and donor linkages. Set up by the RSPs in 2000, RSPN works closely with government, donors and communities to promote the RSP approach to community driven development that has significant pro-poor impacts. The scale of RSP work now covers 3,766 union councils in 125 districts and five regions of Pakistan's Federally Administered Tribal Areas. Community Organisations now number 390,962 with a membership of 6.65 million households, covering a population of 43.2 million.

### ***Aga Khan Foundation***

FOCUS Humanitarian Assistance is the lead implementing agency for humanitarian assistance of the Aga Khan Development Network (AKDN) in Pakistan, drawing on its extensive experience in disaster management and response. The Aga Khan University, and the Aga Khan Health Service also provide extensive emergency medical support in disasters, working closely with various ministries and departments of the Pakistan government, UN agencies, and international multilateral and bilateral partners.

---

<sup>27</sup> Pakistan Humanitarian Forum. [www.pakhumanitarianforum.org](http://www.pakhumanitarianforum.org)

<sup>28</sup> Rural Support Programmes Network (RSPN). [www.rspn.org.pk](http://www.rspn.org.pk)

### ***National Humanitarian Network (NHN)***

The National Humanitarian Network (NHN) is a network of NGOs (NGOs) in Pakistan, led by an elected Chair and Central Executive Committee nationally, with provincial/regional chapters in five provinces (Punjab, Sindh, Baluchistan, Khyber Pakhtunkhwa/FATA, Azad Jammu Kashmir) while Gilgit-Baltistan chapter is in the stage of establishment. Founded in 2010 in result of interactive dialogue in National Disaster Management Authority (NDMA) to act as an independent and vibrant voice to engage with stakeholders throughout Pakistan for promotion of humanitarian values by influencing policies and building capacities to ensure rights based humanitarian response.<sup>29</sup>

Both PHF and NHN play a vital role in disaster response and the humanitarian architecture of Pakistan by acting as a forum for their members to raise issues with Government and to share experiences and knowledge from the field. Both agencies are important contacts for donors and foreign humanitarian organisations seeking to establish partnerships and identify implementing agencies when responding to disasters.

### ***Pakistan Poverty Alleviation Fund (PPAF)***

The Pakistan Poverty Alleviation Fund one of the largest sources of pro-poor spending in the country, the Pakistan Poverty Alleviation Fund (PPAF) is the lead agency for poverty reduction in Pakistan. PPAF will utilise its endogenously generated grant fund for rapid deployment of resources at the community level in order to ensure an immediate and effective response to a disaster, encompassing relief and early recovery. PPAF also undertakes relief and recovery operations in a community focused planned and coordinated way.

### ***Pakistan Centre for Philanthropy (PCP)***

The Pakistan Centre for Philanthropy (PCP)<sup>30</sup> is the accreditation body for both INGOs and NGOs in Pakistan. In the process for registration of an INGO in Pakistan, PCP conducts assessments on behalf of the Federal Board of Revenue, Ministry of Interior and other relevant Government authorities. For local NGOs, PCP conducts accreditation to ensure governance, accountability and compliance. PCP is a useful reference point for donors and INGOs to identify suitable local implementing partners.

## **Private Sector**

Pakistan has a vibrant private sector from small and medium companies to large national and multi-national corporations. Many companies provide relief in times of emergencies, often through their Corporate Social Responsibility Programs. Some of the best examples are companies like global logistics company DHL which has in the 2010 floods, provided substantial support to government authorities in cargo and logistics management of relief goods. Other multi-national companies like Nestle have also provided extensive support in past disasters through provision of clean drinking water and other items to assist affected communities.

**Recommendation: Draft SOPs for the Private Sector for Coordination in response could be developed in consultation with NDMA) to formalise and streamline response. .**

<sup>29</sup> National Humanitarian Network. [www.nhn.org.pk](http://www.nhn.org.pk)

<sup>30</sup> [www.pcp.org.pk](http://www.pcp.org.pk)

### ***Federation of Pakistan Chambers of Commerce & Industry (FPCCI)***

The FPCCI has an extensive network covering all of Pakistan. FPCCI has under its umbrella, 50 Chambers of Commerce and Industry, 11 Women's Chambers of Commerce & Industry, 8 Chambers of Small Traders, 5 Joint Chambers of Commerce Industry, 117 All Pakistan Associations, representing Industry, Trade and Service sectors. FPCCI is a good contact point for information on where relief goods can be purchased in Pakistan by foreign response organisations. Rather than import relief goods, a policy to 'Buy Local' is preferred by the Government as it helps stimulate the local economy, provides employment, and helps the affected communities recover

**Recommendation: The FPCCI could bring together all its subsidiaries/branches and member organisations to develop and publish own guidelines for disasters in consultation with NDMA (for distribution to members).**

### ***Philanthropists and Overseas Pakistanis***

Pakistanis are extremely generous, particularly during natural disasters. In past large-scale disasters, people from across the country privately contributed enormous sums of money and relief goods. Overseas Pakistanis also contributed substantially, often through local contact. While this was gratefully received it became clear that there were substantial problems with coordination with some affected areas receiving multiple deliveries and assistance and others receiving none leading to further distress, movement of emergency vehicles, and other issues.

**Recommendation: There is a need to create a platform for individual donors to coordinate with NDMA to ensure that the type of relief assistance is appropriate and distributed in accordance with identified needs.**



## Section

# 9

## Health Response – Foreign Medical Teams

The Health system in Pakistan was devolved to the Provinces under the 18th Amendment to the Constitution. At National level, the **Ministry of Health Services, Regulation and Coordination** is the key agency for international cooperation. It also coordinates with the **National Health Emergency Preparedness Network (NHEPRN)**, **NDMA**, and the **Provincial Health Departments**. The **World Health Organisation (WHO)** is the key UN agency which provides support to the Government of Pakistan on health response. The Food & Agriculture Organisation (FAO) on the UN is also a stakeholder in health matters related to animal to human disease transmission.

Health is a critical component of response and in past disasters, the local capacity has been overwhelmed. This often requires the deployment of foreign field hospital and medical teams. Countries including Australia, China, Cuba, EU, Italy, Turkey, and Saudi Arabia have added much needed capacity to the health response in past mega-disasters in Pakistan through such deployments.

Currently, no specific guidelines have been developed to manage foreign assistance in response to a health crisis or for foreign field hospitals and medical teams. The following section describes the processes related to foreign assistance to support local capacity and hosting mechanisms in disasters and epidemics.

### Foreign Medical Teams (FMT)

FMTs are teams of health professionals (doctors, nurses, physiotherapists, paramedics, etc.) that provide direct clinical care to people affected by emergencies and disasters, and support local health systems.

FMT can be from both governmental (civil and military teams) and non-governmental organisations and their response can be national or international. Traditionally, these teams have been focused on the management of trauma and surgical care, but the response to the Ebola outbreak demonstrated the value they can have in other contexts, such as epidemics.

FMTs work under the overall guidance of the Classification and Minimum Standards for Emergency Medical Teams in sudden-onset disasters.

### Classification of FMT

#### *FMT Type 1: Outpatient Emergency Care*

**Mission:** Provides outpatient initial emergency care of injuries and other significant health care needs.

**Minimum Benchmark:** Capable of treating at least 100 outpatients per day and function during day-time. (rather than 24 hours)

**Key Services:**

- Triage, Assessment and First Aid
- Stabilisation and referral of severe trauma and non-trauma emergencies
- Definitive care for minor trauma and non-trauma emergencies

**Staffing:** At least 3 doctors trained in emergency and primary care, with the remainder nurses, paramedics and logistic staff. (Ideally doctor: nurse ratio = 1:3). Staff skilled in emergency and trauma care, maternal and child health, knowledge of endemic disease management

Type 1 FMTs can work from suitable existing structures, or supply their own fixed or mobile outpatient facilities, such as tents or special equipped vehicles. They should be available to arrive in the fastest possible time, ideally within 24–48 hours, and be considered light and portable. Their staff should be experienced in those elements of initial trauma care that relates to triage on a mass scale, wound and basic fracture management, basic emergency care of paediatric, obstetric, mental health and medical presentations.

Type 1 FMTs should be in a position to stay for at least 2–3 weeks, or even longer if they are specialised in ambulant follow up for long term wound care and rehabilitation.

***FMT Type 2: Inpatient Surgical Emergency Care***

**Mission:** Provide inpatient acute care, general and obstetric surgery for trauma and other major conditions.

**Minimum Benchmark:** Perform at least 7 major or 15 minor operations daily with at least 20 inpatient beds per one operating table and be able to function 24 hours per day, seven days per week (24/7) if required.

**Key Services:**

- Intake/Screening of new and referred patients, counter-referral
- Surgical triage and assessment
- Advanced life support
- Definitive wound and basic fracture management
- Damage control surgery
- Emergency general and obstetric surgery. Note: Obstetrics can either be provided or arranged with a local partner or other FMT
- Inpatient care for non-trauma emergencies
- Basic anaesthesia, X-ray, sterilisation, laboratory and blood transfusion
- Rehabilitation services and patient follow up

**Staffing:** Including doctors skilled in emergency and general medical care (including paediatrics and maternal health), surgical and anaesthetic staff for theatre, and medical, nursing and logistic staff to

manage inpatients. Ratios must reach or exceed: anaesthetic technician/anaesthetist ratio 1:1 with surgeons; 5 OR technical staff per OT table Nursing ratio of at least 1 nurse; 8 ward beds (24 hours).

The original provider of the type 2 FMT may bring each of these key services or the organization may declare themselves capable of receiving and integrating specialised care teams (see below) to work within their facility (e.g. burns and emergency obstetric care) to achieve all services.

Type 2 FMTs must be able to provide inpatient care, and have the ability to receive, screen and triage new and referred patients. Surgical capability must be at a minimum standard as articulated in the technical minimum standard sections below.

Types 2 FMTs may either be offered within a suitable existing structure, or provide a temporary facility. This must be articulated in the offer of an FMT to the host country. Minimum standards apply to that structure and are available in the logistics technical standards below.

Type 2 services are considered most useful from day one but it is anticipated that time to operation in the field may be several days. Type 2 FMTs should be available for at least 3 weeks but ideally longer. Those FMTs deployed in the first seven days can expect to see a large mixed burden of disease, with orthopaedic and wound injuries predominating, but also the normal expected need for acute surgery, including Emergency Obstetric Care.

The acute trauma surgery is expected to decline quickly, and be replaced by those with complications of their incompletely managed wounds and fractures, as well as the normal local burden of surgical and medical disease.

Type 2 FMTs must have staff capable of managing this expected epidemiology, and should have a specific plan to manage the co-morbidity of normal disease patterns, and of other medical conditions with complications or severity that requires admission, incl. infectious disease, non-communicable disease, obstetric and paediatric presentations expected.

### ***FMT Type 3: Inpatient Referral Care***

**Mission:** Provide complex inpatient referral surgical care including intensive care capacity.

**Minimum Benchmark:** Must have at least 2 operating tables in two separate rooms within the theatre area, at least 40 inpatient beds (20 per table) and have the capability to treat 15 major or 30 minor surgical cases a day.

#### **Key Services:**

- Intake/Screening of referred and new patients, surgical triage and assessment, plus counter-referral
- Capacity to provide type 2 services when needed
- Complex reconstructive wound and orthopaedic care, when required
- Enhanced, X-ray, sterilisation, laboratory and blood transfusion
- Rehabilitation services and patient follow up
- High level paediatric and adult anaesthesia
- Intensive care beds with 24/7 monitoring and ability to ventilate

**Staffing:** Personnel must comply with FMT 2 size and ratios plus; orthoplastic reconstruction

surgeon(s). Nursing ratio 1:2 beds for Intensive care (24 hours). Logistics and allied health including rehabilitation to reflect the increased size and complexity.

Type 3 FMTs should be considered an option to provide a high-level referral service to those type 1 and 2 teams (both local and foreign) that cannot provide services of that standard. These must include 4–6 intensive care beds with the ability to ventilate patients and reconstructive wound and orthopaedic capability, but can also include other specific specialist groups and services (e.g. maxillo-facial, specialist paediatric, etc.). The original provider of the type 3 FMT may bring these or may declare themselves capable of receiving and integrating specialised care teams (see below) to work within their facility (e.g. an ortho-plastic reconstructive group of surgeons and operative nurses).

Type 3 FMTs should be offered immediately, and upon agreement, deploy without delay, but are unlikely to be operational in the field for at least 5–7 days. In view of their referral function and the complexity of the cases they are likely to manage, they should be considered a service that is only appropriate to deploy for at least 2 months. Teams may deploy into existing health facilities or offer their services within their own structures (field hospital).

### **Additional Specialised Care Teams**

These teams may be as small as two or three senior specialists and provide additional specialised care embedded within type 2 or 3 FMTs or a national Hospital. They must bring appropriate equipment, maintenance and supplies adequate to their specialty area. Like others FMTs, Additional Specialised Care Teams must adhere to the FMT Guiding Principles and core standards, and follow current guidelines for the specialty represented and ensure care provided is appropriate to context and identified needs.

**Specialised services** may include:

- Burn Care: Specialist surgical +/- allied health teams with expertise in management of burns and burn complications
- Dialysis and care of crush syndrome: Specialist nephrology and renal care teams for the care of crush syndrome and expert advice on mass dialysis
- Maxillo-facial surgery: Specialist maxillo-facial surgical teams +/- operative teams with expertise in the management of complex facial trauma and facial reconstruction
- Orthoplastic surgery: Specialist orthopaedic and plastic teams, ideally with operative theatre and allied health and rehabilitation support to provide complex orthopaedic and wound surgical care and reconstruction.
- Intensive Rehabilitation: Specialist rehabilitation teams to provide support to FMTs and hospitals unable to provide rehabilitation services
- Maternal Health: Specialist providers of midwifery and obstetric surgical care able to provide this care within FMTs unable to do so.
- Neonatal and Paediatric: Provide specialist paediatric and neonatal care.
- Transport and Retrieval: Specialist teams for the transfer of critically ill patients in special circumstances after consultation with the host ministry of health.

Additional services may be provided by other agencies or the local health services

## Core Standards for Foreign Medical Teams

Each FMT type must comply with the minimum technical standard for the service per type of care. The technical standards are considered the minimum acceptable, but all teams with the resources and experience to exceed these standards are encouraged to do so, while considering the effect this may have on existing health system:

- Agree to register with the NDMA or lead international agency on arrival and collaborate with inter-agency response coordination mechanisms at global, national and sub-national levels, as well as with other FMTs and health systems.
- Will undertake to report on arrival what type, capacity and services they can offer based on the international FMT classification system
- Will undertake to report at regular intervals during response, and prior to departure, to the national authorities and the cluster, using national reporting formats, or if not available, the agreed international reporting format.
- Will undertake to keep confidential records of interventions, clinical monitoring and possible complications.
- Will undertake for the individual patient, to have record of treatment performed and referral for follow-up planned as needed
- Will undertake to be part of the wider health referral system, and depending on type, offer to accept or refer or both accept and refer patients to other FMTs, the national health system or, if approved, other countries
- FMTs will adhere to professional guidelines: all their staff must be registered to practice in their home country and have license for the work they are assigned to by the agency
- FMTs will ensure that all their staff are specialists in their field, appropriately trained in either war or sudden onset disaster surgical injury management. The majority should have training and experience in global health, disaster medicine and providing care in austere environments. Acknowledging the need to train and provide experience to new staff, there may be scope for junior and inexperienced staff in the later phase of a disaster response and working under direct supervision of experienced colleagues.
- FMTs will ensure that all pharmaceutical products and equipment they bring complies with international quality standards and drug donation guidelines
- FMTs are self-sufficient and not put demand on logistic support from the affected country, unless agreed otherwise before deployment.
- FMT comply with minimal hygiene and sanitation standards, including adequate management of medical waste
- FMTs must ensure the team and individuals within it are covered by adequate medical malpractice insurance. FMTs must have mechanisms to deal with patient complaints and allegations of malpractice.
- FMTs must have arrangements in place for the care of their team members' health and safety including repatriation and exit strategies if required.

## Entry of Foreign Field Hospitals (FFH)

Field hospitals may be used to substitute or complement medical systems in the aftermath of sudden-impact events that produce disasters for three distinct purposes:

- Provide early emergency medical care (including Advanced Trauma Life Support – ATLS). This period lasts only up to 48 hours following the onset of an event.
- Provide follow-up care for trauma cases, emergencies, routine health care and routine emergencies (from day 3 to day 15).
- Act as a temporary facility to substitute damaged installations pending final repair or reconstruction (usually from the second month to two years or more).

The FFH should meet some essential requirements to ensure that it benefits the affected population. Ideally, it should also meet additional (optional) criteria

## Terminologies

TERMS	DEFINITION
Field Hospital	<p>A mobile, self-contained, self-sufficient health care facility capable of rapid deployment and expansion or contraction to meet immediate emergency requirements for a specified period of time. A field hospital can be set up in an existing structure or in a structure, tent or similar that is brought with the FMT. It should be noted that this term refers to the facility only, and does not specify the team or the type or level of services provided.</p>
Foreign Medical Team	<p>International medical teams that have registered and agreed to comply with the standards and principles outlined below.</p> <p>It refers to groups of health professionals and supporting staff outside their country of origin, aiming to provide health care specifically to disaster affected populations They include governmental (both civilian and military) and non-governmental teams.</p> <p>A FMT has staff to provide basic and/or advanced healthcare based on international classification levels and minimum standards during a limited time period in existing or temporary structures, with or without field hospitals.</p> <p>Any individuals or groups that do not fall within the definition and cannot comply with the standard should either consider joining a recognised organisation that provides FMT or not responding in the aftermath of a sudden onset disaster.</p>
Sudden Onset Disaster	<p>SODs are disasters that occur with little or no warning, meaning there is insufficient time for the complete evacuation of the at risk populations.</p> <p>A disaster is defined by the United Nations Office for Disaster Risk Reduction as a serious disruption of the functioning of a community or a society involving widespread human, material, economic or environmental losses and impacts, which exceeds the ability of the affected community or society to cope using its own resources.</p>

Immediate Aftermath	<p>Refers to response and early recovery generally within the first months after the disaster. The timeframe considered is the initial response period in which care is focused on the injured and those directly affected by the disaster rather than the temporary replacement of local health services.</p> <p>This period is not fixed and will be influenced by the size of the disaster, numbers of people affected, the level of imbalance between healthcare needs and resources, damage to infrastructure, geographic access to those affected and their health seeking behaviour and whether secondary events occur.</p>
Emergency Care	<p>Health care of all age groups, with injuries or acute health care requirements. It includes the initial assessment, resuscitation, operative (and anaesthetic) care, postoperative care and rehabilitation of the injured as well as emergency care of any associated co-morbidities or illness.</p> <p>FMTs must be able to recognise emergent care requirements in the affected population, and if unable to treat them, must have a clear plan of referral to the national health system or other FMTs providing such care.</p>
Qualified Health Worker	<p>A formally trained clinical provider, such as a physician, nurse, clinical officer or medical assistant (30) who has been recognised as such by a competent professional body. The term qualified, in this context, does not refer to their qualities to be part of a FMT.</p>
Minimum Deployment Standards	<p>Criteria, which foreign medical teams must adhere to. While many standards describe structure and performance during deployment these should be acknowledged and implemented prior to deployment. This allows the affected country to have confidence in the capabilities of the FMT and an opportunity to hold FMT accountable if they do not meet their stated capability.</p> <p>A standard is an object or quality or measure serving as a basis for example or principle to which others conform or by which others conform or should conform or by which the accuracy or quality of others is judged.</p>
Needs Based Response	<p>A response in which the assistance provided is both appropriate to the anticipated epidemiological profile of the disaster and health profile of the affected community as well as being consistent with the actual health care required by that community.</p>
FMT Type 1: Outpatient Emergency Care	<p>Outpatient initial emergency care of injuries and other significant health care needs.</p>



FMT Type 2: Inpatient Surgical Emergency Care	Inpatient acute care, general and obstetric surgery for trauma and other major conditions.
FMT Type 3: Inpatient Referral Care	Complex inpatient referral surgical care including intensive care capacity.

# DISASTER RESPONSE TIMELINE AND NEEDS

- Triage
- First Aid
- Acute Medical & Surgical Care
- Search and rescue of victims
- Emergency Shelter
- Food
- Water
- Public Information
- Transitional shelter planning
- Repair of lifelines (power, water, communications)
- Debris removal
- Security
- Hygiene
- Vector Control
- Sanitation
- Waste Disposal
- Fuel/heating/lighting
- Nutrition feeding program
- Reproductive Health
- Mental Health & Psychosocial Support
- Protection
- Transport
- Communication

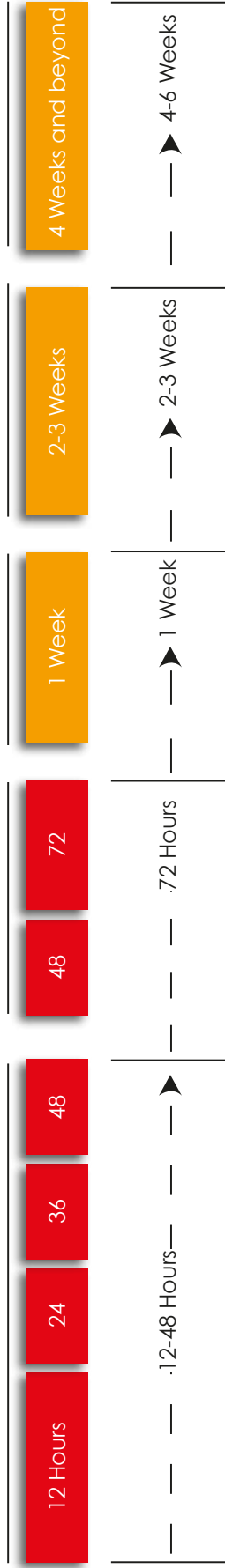

- Request for and/or acceptance of international assistance by host government
- Deployment of Assessment Teams (FACT, UNDAC, RDRT, ERU)
- Deployment of USAR Teams
- Appointment of HC
- Set up of Humanitarian Information centre
- Cluster response planning
- ICRC Family Link Network
- Initial CERF Allocation
- Launch of flat appeal
- Exit of Med. & heavy USAR Teams after 10 days of deployment
- FACT Teams exit 2-4 weeks after deployment
- UNDAC Teams exit after 3 weeks of deployment
- 2nd CERF allocation
- Revised Flash Appeal

# EMERGENCY

## Section

# 10

## Civil-Military Coordination (CMCoord)

**CIVIL-MILITARY DEFINITION:** In the context of a humanitarian response the term “Civil-Military” refers to the relationship between the humanitarian community and the military.

In a disaster situation, NDMA will be the coordination point for the humanitarian community and the military to ensure a common operation picture.

### **International Principles on Civil-Military Coordination**

Humanitarian assistance and disaster relief operations require extensive coordination between the host government, inter-ministry/department/agency, and military, but also with and by foreign governments, humanitarian and multinational organisations, and foreign militaries.

In past disasters in Pakistan, issues have arisen in relation to the interpretation of international CMCOORD guidelines and the situation on the ground. Similar situations have been encountered in large-scale disasters in other countries and this can have a profound impact on a rapid response.

The international humanitarian community follows a number of international Guidelines of Civil-Military Coordination. While these are valuable and respected, they do not always align with local conditions.

### ***UN Humanitarian Civil-Military Coordination (UN CMCoord)*<sup>31</sup>**

When an emergency or natural disaster creates humanitarian needs, many countries will deploy their militaries or paramilitary organisations to respond. Bilateral support to disaster-affected States can also be provided through international deployment of foreign military actors and assets.

When local and international humanitarian organisations are also involved in that response, it is essential that they can operate in the same space without detriment to the civilian character of humanitarian assistance. UN-CMCoord facilitates dialogue and interaction between civilian and military actors, essential to protect and promote humanitarian principles, avoid competition, minimise inconsistency and, when appropriate, pursue common goals.

UN-CMCoord is a framework that enhances a broad understanding of humanitarian action and guides political and military actors on how best to support that action. It helps to develop context-specific

---

<sup>31</sup> <http://www.unocha.org/what-we-do/coordination-tools/UN-CMCoord/overview>

policy based on internationally agreed guidelines, and it establishes humanitarian civil-military coordination structures, ensuring staff members are trained to make that coordination work.

***Civil-Military Guidelines: UNOCHA - Oslo Guidelines –on the Use of Foreign Military and Civil Defence Assets in Disaster Relief***

The Oslo Guidelines –on the Use of Foreign Military and Civil Defence Assets in Disaster Relief<sup>32</sup> are the international guide to address the complexities of use of military assets in disaster relief as a ‘last resort’ when no civilian transportation is available.

The ‘Last Resort’ guideline – the use of military assets for delivering relief – is often an area of the greatest difference in interpretation. In natural disasters, the terrain in Pakistan makes it logical for using the immense logistical capabilities and assets of the military where it will provide the fastest means of getting aid to remote or cut-off communities. For some humanitarian organisations, the use of military assets may be against their own guiding principles for response.

The Lessons Learned from the 2010 super floods highlight how different the opinions and interpretations can be between the humanitarian community and the military and can be a point of friction. **To avoid delays, advice should be sought from NDMA to ensure a local understanding of the ground situation to assist in making a determination.**

---

<sup>32</sup> UNOCHA. Oslo Guidelines – Guidelines on the Use of Foreign Military and Civil Defence Assets in Disaster Relief. March 2007. [https://docs.unocha.org/sites/dms/Documents/Oslo%20Guidelines%20ENGLISH%20\(November%202007\).pdf](https://docs.unocha.org/sites/dms/Documents/Oslo%20Guidelines%20ENGLISH%20(November%202007).pdf)

## Section

# 11

## Humanitarian Principles & Minimum Standards

### Gender, Children, and Most Vulnerable (Ensuring consideration)

In a disaster, women in general may be affected differently from men because of their social status, family responsibilities or reproductive role, but they are not necessarily vulnerable. They are also resourceful and resilient in a crisis and play a crucial role in recovery. However, a proper Gender analysis can help to identify those women or girls who may be vulnerable and in what way and they can be included in the programming needs for the vulnerable community members.

The Child Protection Working Group (CPWG) is the global level forum for coordination of child protection in humanitarian emergencies bringing together NGOs, UN agencies, academics and others. The CPWG constitutes an “area of responsibility” within the Child Protection Cluster.<sup>33</sup> The CPWG has developed a set of international minimum standards for protection of children.<sup>34</sup>

The **National Disaster Management Authority Gender and Child Cell** is responsible for the national policies related to Gender, Children and Most Vulnerable. Each of the PDMA also have Gender Cells. To ensure compliance with local policies, responders should engage with NDMA or the relevant **PDMA** for further information and to ensure that all response activities include considerations related to gender, children, and the most vulnerable.

### National Policy Guidelines of Vulnerable Groups in Disasters – NDMA Gender and Child Cell<sup>35</sup>

#### *Overarching National Policy Guidelines on Vulnerable Groups in Disasters*

- Promote participation of women, men, older persons and persons with disabilities in all phases of disasters, from disaster planning and preparedness to disaster response and recovery.
- Ensure collection and availability of disaggregated data on children, women, older persons and persons with disabilities (specifying type of disability).
- System of relief distribution should ensure accessibility to all vulnerable groups – women (especially widows), children, (especially Child-Headed Households), older persons and persons

<sup>33</sup> Child Protection Working Group. [www.cpwg.net](http://www.cpwg.net)

<sup>34</sup> Child Protection Working Group. Minimum Standards for Child Protection in Humanitarian Action. <http://cpwg.net/wp-content/uploads/sites/2/2014/03/CP-Minimum-Standards-English-2013.pdf>

<sup>35</sup> [http://www.ndma.gov.pk/plans/gcc\\_policy.pdf](http://www.ndma.gov.pk/plans/gcc_policy.pdf)

with disabilities.

- Provide access to specialised medical care and equipment to cater to reproductive, paediatric and disability related needs of affected persons.
- Create Friendly Spaces as relief sites and camps for women and children and include services for older persons and persons with disabilities.
- DRR and DRM should be included in education curriculum, highlighting the concerns of vulnerable groups.
- Strengthen capacities of government ministries, line departments, PDMAs, DDMAs, and relief and rescue workers in addressing gender, child protection and vulnerable groups' needs in disasters.
- Designate GCC focal persons in relevant line departments for gender mainstreaming in disasters and provide them with proper training.
- Utilise community knowledge, skills and local networks (such as Girl Guides, Boy Scouts and LHWs) and strengthen local leadership for DRR and DRM.
- Community based DRR should include Child Protection in Emergency (CPiE), gender and disability components.
- Referral systems and complaint mechanisms should be in place to address gender based violence, child protection issues, and abuse of older persons and persons with disabilities (such as help line, complaint box), with trained staff available.
- Code of Conduct should be available and adhered to by all humanitarian workers specifying ethical standards and local/cultural norms to conform to in disaster response.
- {Psychosocial support and post trauma stress counselling should be provided for women, children, older persons and persons with disabilities.
- Intensive and comprehensive gender sensitisation and orientation programs should be undertaken for policy makers and implementers to effectively reduce disaster vulnerabilities and risks.
- Holistic and multi-stakeholder approach should be undertaken to address the needs and concerns of vulnerable groups in DRM.
- Coordinated joint actions should be ensured in political, technical, social, developmental and humanitarian processes.
- Formulation of DRR and DRM plans should include specific gender, child protection and other vulnerable groups' issues, concerns and actions in close collaboration with the relevant line departments and stakeholders.
- Design SOPS for DDMAs and all departments dealing with issues of vulnerable groups in disasters for division of roles and responsibilities and better coordination.
- General and Child Cells in R/PDMAs should be strengthened and made sustainable by government.
- Social protection measures of Government of Pakistan, such as BISP, Watan Cards, and land allocation for the landless rural population should be made accessible to the disaster affectees within vulnerable groups to facilitate their socio-economic recovery.

## Gender

Response, Recovery, and Rehabilitation		
Safety & Security	Wash & Health	Shelter, Food & NFIs
<ul style="list-style-type: none"> <li>- Strengthen community based safety mechanisms by involving local community women in EWS, response and rescue.</li> <li>- Relief sites and camps should ensure attention to women's security needs, such as separate washrooms with locks, adequate light, water and sanitation facilities etc.</li> </ul>	<ul style="list-style-type: none"> <li>- Women's fair and equitable access to basic services should be ensured, particularly in health and hygiene.</li> <li>- Female doctors and psychosocial supports personnel should be available for women.</li> <li>- Mobile medical units equipped with safe delivery, postnatal facilities and referral should be in place.</li> </ul>	<ul style="list-style-type: none"> <li>- Evacuation and relocation measures must make provision for women's access to transportation and protection in culturally sensitive areas.</li> <li>- Women perspective should be included in designing shelter and rehabilitation projects.</li> </ul>

## Children

Response, Recovery and Rehabilitation		
Safety & Security	Wash & Health	Shelter, Food & NFIs
<ul style="list-style-type: none"> <li>- Safe interim care arrangements are identified and accessible for boys and girls of all ages.</li> <li>- Child Protection in Emergency coordination mechanisms are in place and functional (such as sub-clusters where activated, or working groups)</li> </ul>	<ul style="list-style-type: none"> <li>- Health staff and other service providers in response teams are trained on identifying and responding to children affected by violence, neglect, abuse and exploitation.</li> <li>- Coordination with relevant sectors (food security, wash, nutrition, education, health, etc) for child appropriate services and assistance.</li> </ul>	<ul style="list-style-type: none"> <li>- Service provisions are tailored for the needs of children with disability during disaster response.</li> <li>- Special measures are in place to ensure that all children headed households have access to humanitarian services.</li> <li>- PDMA's should identify infrastructures prior to disasters as temporary shelters so that schools are not used as the only shelter areas.</li> </ul>

## Older Persons and Persons with Disabilities

<b>Response, Recovery and Rehabilitation</b>		
<b>Safety &amp; Security</b>	<b>Wash &amp; Health</b>	<b>Shelter, Food &amp; NFIs</b>
<ul style="list-style-type: none"> <li>- Establish systems and procedures for prevention from abuse &amp; exploitation of older people and persons with disability.</li> </ul>	<ul style="list-style-type: none"> <li>- Health, WASH, and shelter facilities should be made accessible for persons with disability and older persons.</li> <li>- Establish mobile health/rehab/relief units to cater to persons with disability and older persons in emergencies.</li> </ul>	<ul style="list-style-type: none"> <li>- Designated shelters and buildings should be made accessible for persons with disability and older persons.</li> <li>- Specific projects including livelihood programmes dedicated for older persons and persons with disability need to be developed as part of disaster management programmes.</li> </ul>



## International Humanitarian Standards

There are numerous international guidelines for disaster response. While mostly, these are non-binding, and there is no universal set of standards to which that all humanitarian agencies adhere. There may be substantial differences in the way I/NGOs act during response.

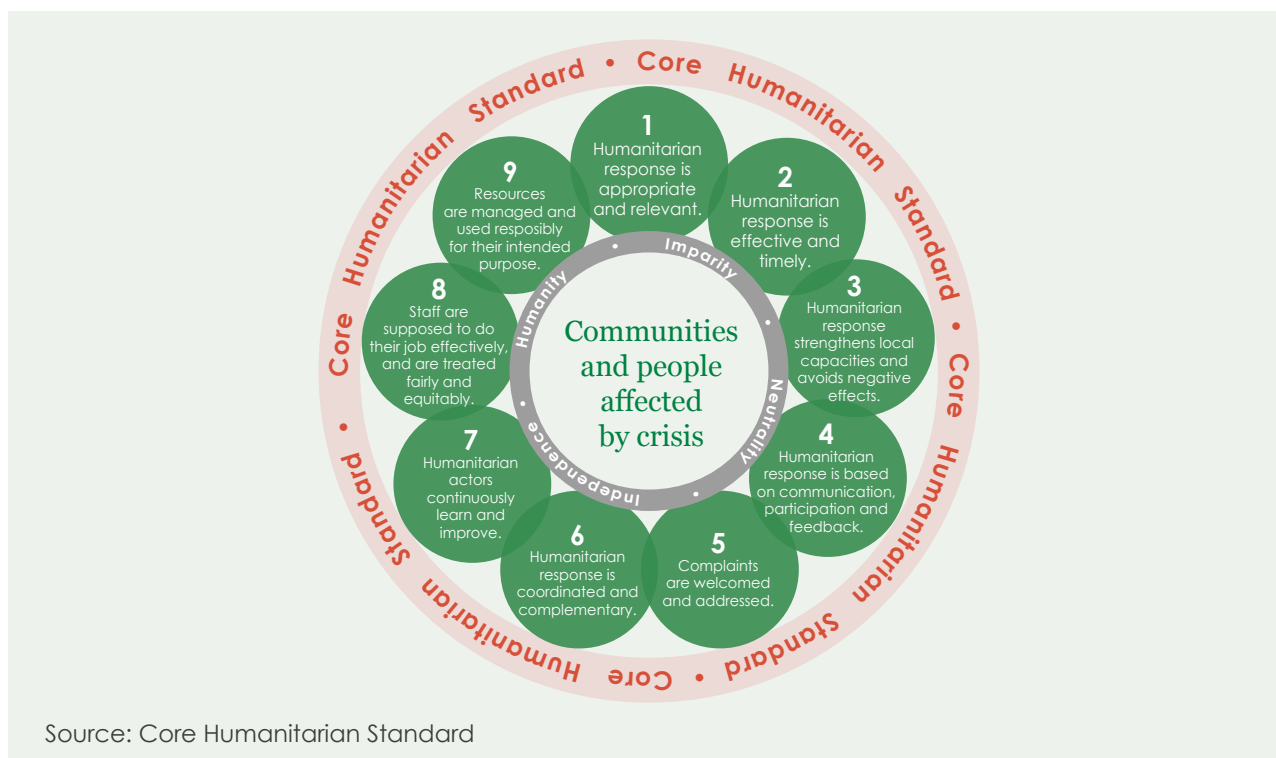

### ***Core Humanitarian Standard***

The Core Humanitarian Standard<sup>36</sup> on Quality and Accountability (CHS) sets out Nine Commitments that organisations and individuals involved in humanitarian response can use to improve the quality and effectiveness of the assistance they provide. It also facilitates greater accountability to communities and people affected by crisis: knowing what humanitarian organisations have committed to will enable them to hold those organisations to account. As a core standard, the CHS describes the essential elements of principled, accountable and high-quality humanitarian action. Humanitarian organisations may use it as a voluntary code with which to align their own internal procedures. It can also be used as a basis for verification of performance.

### ***Sphere Handbook - Humanitarian Charter and Minimum Standards in Humanitarian Response***<sup>37</sup>

Sphere is one of the most widely known and internationally recognised sets of common principles and universal minimum standards in life-saving areas of humanitarian response. The Sphere Handbook puts the right of disaster-affected populations to life with dignity, and to protection and assistance at the centre of humanitarian action. It promotes the active participation of affected populations as well as of local and national authorities, and is used to negotiate humanitarian space and resources with authorities in disaster-preparedness work.

<sup>36</sup> Core Humanitarian Standard on Quality and Accountability (CHS).

<https://corehumanitarianstandard.org/files/files/Core%20Humanitarian%20Standard%20-%20English.pdf>

<sup>37</sup> Sphere Handbook, Humanitarian Charter and Minimum Standards in Humanitarian Response. 2011. .

<http://www.sphere-handbook.org/>

## Common Principles, Rights and Duties

We offer our services as humanitarian agencies on the basis of the principle of humanity and the humanitarian imperative, recognising the rights of all people affected by disaster or conflict – women and men, boys and girls. These include the rights to protection and assistance reflected in the provisions of international humanitarian law, human rights and refugee law. These rights can be summarised as:

- The right to life with dignity
- The right to receive humanitarian assistance
- The right to protection and security

While these rights are not formulated in such terms in international law, they encapsulate a range of established legal rights and give fuller substance to the humanitarian imperative. The minimum Sphere standards cover four primary life-saving areas of humanitarian aid:

- Water supply, sanitation and hygiene promotion
- Food security and nutrition
- Shelter, settlement and non-food items
- Health action

**Note: The Sphere Standards are currently undergoing a major update. The new version is expected in 2018.**

## Do No Harm – Unintended Consequences

**Sphere Protection Principle 1: Avoid exposing people to further harm as a result of your actions.**

Those involved in humanitarian response must take all steps to avoid or minimise any adverse effects of their intervention, in particular the risk of exposing people to increased danger or abuse of their rights. This principle includes the following elements:

- The form of humanitarian assistance and the environment in which it is provided do not further expose people to physical hazards, violence or other rights abuse.
- Assistance and protection efforts do not undermine the affected population's capacity for self-protection.
- Humanitarian agencies manage sensitive information in a way that does not jeopardise the security of the informants or those who may be identifiable from the information.

The **Core Humanitarian Standard** emphasises that all steps should be taken to 'identify and act upon, potential or actual, unintended negative effects in a timely and systematic manner'.<sup>38</sup>

## Principles and Rules for Red Cross and Red Crescent Humanitarian Response

The International Federation of Red Cross/Red Crescent provides a comprehensive set of principles for all aspects of humanitarian response. The **Principles and Rules for Red Cross and Red Crescent Humanitarian Response**<sup>39</sup> guides all IFRC responders in all aspects of engagement with all stakeholders including affected communities, government agencies, UN and other humanitarian agencies, militaries and other actors.

<sup>38</sup> Core Humanitarian Standard on Quality and Accountability (CHS).

<https://corehumanitarianstandard.org/files/files/Core%20Humanitarian%20Standard%20-%20English.pdf>

<sup>39</sup> Principles and Rules for Red Cross and Red Crescent Humanitarian Response.

<http://www.ifrc.org/Global/Documents/Secretariat/Accountability/Principles%20Rules%20for%20Red%20Cross%20Red%20Crescent%20Humanitarian%20Assistance.pdf>

## Linking Response to Recovery

Disasters occur on a continual basis, causing large-scale damages and losses to countries and communities. Disaster response, which naturally follows a disaster impact - is the provision of assistance or intervention during or immediately after a disaster to meet the immediate life preservation and basic subsistence needs of affected people. The primary aim of disaster response is to rescue from immediate danger, and stabilisation of the physical and emotional condition of survivors through relief.

Emergency relief and response can stretch for a long time or can end relatively quickly. It depends according on the scale, type and context of the disaster. Typically the response/relief phase takes between one and six months and is composed of a search and rescue phase in the immediate aftermath of a disaster followed by a medium-term phase for relief and temporary shelters, devoted to stabilising the survivors' physical and emotional condition.<sup>41</sup>

Rapid needs assessments are naturally carried out to help identify immediate needs after the disaster impact. In all cases, when systems are in place and people are no longer worried about survival, the response phase of a disaster will transition into the early recovery. The failure to recover adequately from a disaster in any context may result in secondary disasters, with equally grave effects. A failed recovery can contribute to disaster becoming endemic as it derails development gains and results in widespread losses.<sup>42</sup> When combined with poorly carried out recovery processes, recurring disasters will continue to increase vulnerability and create chronic conditions of risk.

While it is vital to recognise early diagnostic indicators from rapid needs assessment for rapid response, decisions, which will affect long-term actions, should not be hastily done. Decision-making processes will need to be reinforced with assessments to prevent further harm and to prepare towards early- to long-term recovery.

**Post-Disaster Needs Assessments (PDNAs)** are tools that are used to have a comprehensive understanding of the medium- to long-term needs, and is naturally focused on understanding the socio-economic impacts, and impacts of the disaster on key sectors and help identify the most pressing recovery needs and provides input into Disaster Risk Reduction (DRR) planning. PDNAs are able collect information on damage losses and recovery priorities, including human development needs, and can be designed or adjusted to determine a range of recovery requirements and priorities, linked to DRR and development objectives. The findings of PDNAs guide the design and implementation of early- and long-term recovery programs and help determine needed assistance.

Recovery provides many development opportunities that may not be possible in “normal” conditions. If properly utilised, these opportunities can improve the effectiveness of recovery from possible future impacts of disasters. The main opportunities for introducing DRR are through recovery – which should be seen as a continuing process that may take place alongside relief and development, and integrated within them. The purpose of recovery should not lead towards returning to “normality”, rather focusing on the opportunities to incorporate DRR and Climate Change Adaptation (CCA), and reducing vulnerability and exposure towards future impacts of disasters.

---

<sup>40</sup> <https://docs.unocha.org/sites/dms/ROAP/Promotional%20Materials/The%20Guide-Web-FINAL.pdf>

<sup>41</sup> <http://www.ifrc.org/en/what-we-do/disaster-management/responding/>

## Time to Leave – Termination of Response

The decision on when to end the response phase will be taken by the Government. There is no set rule of timing the end of response. It will always vary according to the decision of the affected country's government disaster authority which may set a specific date when all response work should cease and preparations made to hand over for the early recovery process. The decision to end response is generally made according to whether the goals have been achieved and the status of the affected community/group and their capacity to cope has stabilised.

An exit strategy must be included from the very beginning when designing a programme not only for response but every phase of the disaster cycle through to development. The exit strategy should facilitate the transition from one programme to the next or to exit completely. A strategy must include keeping the community informed and ensure a common understanding of the starting and ending points of a programme. The exit strategy may change during the course of the programme due to a change in circumstances or further community crises.

- Do not let the community think that you will stay forever
- Be realistic about what can be achieved
- Look for opportunities to help the community transition to the next phase (recover, rehabilitation, development) and sustainability.

### *Handing Over*

As the response phase is winding down, humanitarian operations should be gradually integrated into the early recovery and reconstruction plans and other activities identified by NDMA, PDMAs, government line ministries, district authorities, and communities.

### *Reporting*

Activity and outcome reports should be prepared for NDMA and Ministries or Departments as required, along with financial reporting of how funds were spent.

### *Gifting of Equipment and Goods*

In past disasters, generous responders have gifted equipment and supplies, particularly in the medical sector, to the Government of Pakistan or other suitable facilities.

If there is a likelihood of equipment or supplies being gifted at the end of a deployment, please ensure that this is in line with Customs Agreements prior to importing. **(See Section on Customs).**

# Annex 1

## Role of Customs Wing in Facilitation of Disaster Response

Topic	Guidance
<p><b>Mandate for disaster response and entry of foreign relief items</b></p>	<p>The Customs Administration of Pakistan immediately starts the entry of relief items once the Prime Minister declares on the recommendation National Disaster Management Authority (NDMA), a Disaster Situation in the calamity hit areas.</p>
<p><b>Procedures for receiving any form of foreign relief assistance through Customs</b></p>	<p>All the Customs Stations of Pakistan including Airports, Sea Ports, Dry Ports and Land Entry Check Posts are notified immediately to start admitting / clearing of the consignments received as foreign relief assistance for clearance as per laid down rules and regulations. Where there are some legal hurdles or requirement of requisite information, the Customs Authorities are directed not to hold the consignments and clear them immediately and seek necessary clarification from the concerned quarters afterwards.</p>
<p><b>Rules and Procedures for receiving any form of foreign relief assistance through Customs</b></p>	<p>The Customs law governing the import of relief goods is provided in Pakistan Customs Tariff (PCT) heading 9911, Sub Chapter-II of Chapter 99 of the first schedule of the Customs Act, 1969 for duty and tax free admission of the foreign relief goods. The said provision of law reads as under:</p> <p>9911: (i) Relief goods donated for free distribution among the victims of natural disaster or other catastrophe, as are certified by the authorised officer of Federal/ Provincial Government;</p> <p>(ii) Plant, machinery and equipment imported by way of donation for installation in the earthquake hit districts as certified by ERR/ National Disaster Management Authority.</p>
<p><b>Special customs procedures for Pharmaceutical Goods, Medical Equipment, ICT Equipment, Other Relief Goods/ Equipment</b></p>	<p>There are no special requirements for these goods by Customs and the same are covered for exemption from duties and taxes according the above referred provisions of law.</p>
<p><b>Tax arrangements for various categories of relief goods; for example, are there any existing exemptions of duty during disasters</b></p>	<p>The exemptions are available for the categories specified in PCT 9911 as mentioned at 3 above.</p>

<p><b>Processes for ‘Gifting’ of relief equipment to Pakistan Organizations (field hospital, medical equipment, ICT equipment or other), at the end of an emergency phase when the foreign organization leaves Pakistan.</b></p>	<p>Government or any public sector organizations are exempt from customs duties and taxes, subject to recommendation of the Cabinet Division and concurrence by the Federal Board of Revenue as provided in PCT 9908 of the Pakistan Customs Tariff. However, FBR discourages gifts or donation of vehicles as a matter of policy. Customs Wing of FBR will be pleased to discuss further changes in the said provision of law for further streamlining the procedures in this regard.</p>
<p><b>Focal Points for Humanitarian relief goods within Customs Wing</b></p>	<p>The Secretary (Grants &amp; Special Exemptions) will be focal point within the Customs Wing of FBR for facilitating the imports of humanitarian relief goods. The respective Additional Collectors of Customs posted at the Airports, Sea Ports, Dry Ports and Border Customs Check posts will be focal points for the purpose in all the field formations.</p>
<p><b>Guidelines or SOPs for reference of responding countries/ organizations</b></p>	<p>Currently there are no such SOPs in place. Customs Wing is ready to lay down the requisite Guidelines and SOPs in consultation with its field formations, NDMA and all other concerned organizations.</p>
<p><b>Coordination mechanisms and reporting guidelines</b></p>	<p>Currently Pakistan Customs utilises its usual/ normal coordination mechanisms and reporting lines, which can cater for the disaster situations too. However, Customs Wing will welcome any recommendations or proposals from NDMA to strengthen the existing coordination and reporting mechanism.</p>
<p>Coordination with MOFA or directly with Pakistan Embassies abroad, prior to dispatch of any relief goods</p>	<p>Customs Wing does not directly coordinate with MOFA or Pakistan Embassies abroad prior to dispatch of any relief goods as there is no such legal or procedural requirement. However, if needed in any specific situation or consignment, Customs Wing welcomes the necessary information or certification from MOFA as well as Pakistan Embassies abroad.</p>

<p>Support of the World Customs Organization (WCO) guidelines on humanitarian relief</p>	<p>When disasters occur, cross-border trade rules applicable to consignments containing humanitarian assistance – particularly for highly regulated items such as foodstuffs, medication, medical equipment, vehicles and telecommunications – are complicated by the imperative need for speed, the unfamiliarity of some donors with local rules, and the disruption of normal procedures. Given its position at borders, Pakistan Customs plays a key role in facilitating the expeditious movement of goods sent as emergency humanitarian aid.</p> <p>Pakistan Customs is an active member of WCO and uses the information on WCO instruments and tools relating to the movement of consignments containing goods for humanitarian assistance, initiatives taken by WCO Members, as well as the UN Office for the Coordination of Humanitarian Affairs (OCHA), Convention on Temporary Admission (Istanbul, 1990) and the Resolution of the Customs Cooperation Council on the Role of Customs in Natural Disaster Relief 2011.</p> <p>Pakistan Customs aims to incorporate all international guidelines and provisions in the form of a Customs General Order (CGO) for better understanding of clearance procedures by the field formations and all other concerned relief goods movers to facilitate disaster response.</p>
<p><b>Other specific organizational matters for disaster response and receiving foreign assistance</b></p>	<ol style="list-style-type: none"> <li>1. Streamlining the procedures for issuance of Original Bills of Lading, Airway Bills and Express Release of consignments from the shipping and airlines.</li> <li>2. To bring Quarantine Division of the Ministry of Food Security and Research and Drug Regulatory Authority (DRAP) into the loop for release of medicines, food items, and for entry of Search &amp; Rescue (SAR) dogs (if required) during relief and rehabilitation operations.</li> <li>3. Encadrement of one or two well-trained BS-20 officers of Pakistan Customs may be posted with NDMA to streamline the Customs related requisite preparedness and coordinate relief efforts during the disaster situations.</li> </ol>





# Annex 2

## Objectives and Services of PMD

Pakistan Meteorological Department is mandated to issue early warnings for all disasters.

- Observatories, data generation and dissemination services including data for the following:
  - Surface weather
  - Earthquake
  - Astronomical
  - Solar radiation
  - Atmosphere Ozone
  - Earth's magnetic field
  - Background air pollution
  - Aeronautical forecast and warning services for Civil Aviation, PAF, ARMY, Navy, and other users.
  - Flood forecast and warning services.
  - Earthquake data and seismic information services to Civil Engineers and other users for dams, bridges, and townships.
  - Farmers' Weather Bulletin and Warning services
  - Public utility and advisory services in various fields of:
    - Planning and development
    - Town planning
    - Construction of roads, bridges, aerodromes, power plants, air-conditioning and other services
    - Provision of meteorological/geophysical data for court cases, insurance claims.
    - Inquiry reports, district gazetteers etc.
    - Military operation services including:

Weather forecasts and monitoring in assigned areas

Meteor reports

- Marine meteorological forecasting and warning services:
  - Air pollution monitoring services
1. Air pollution monitoring Services
  2. Research activity in the following fields:

- Meteorology
- Climatology
- Hydrology
- Oceanography
- Atmospheric physics
- Environmental pollution
- Geophysics
- Agricultural meteorology

3. Astronomical services in the following fields:

- Sun rise/set timings
- Namaz timings and Qibla Direction calculations
- Morning/evening twilight timings
- Sun/moon eclipse
- Sighting of new moon

4. Training in meteorology and geophysics for:

- Departmental trainees
- Trainees from other organizations
- Foreign training
- PAF (Met. Branch) trainees

Early Warning System Protocol of PMD

- a. PMD provides regular “Climate Outlook” updates and translates into impact outlook and advice for flood/drought preparedness action and/or agricultural system adaption action that is well understood by famers and community members at risk of floods and drought;
- b. Make arrangements for SMS delivery of critical warnings of earthquakes and seismicity;
- c. Agrees with NDMA/PDMA on a protocol for dissemination of impact outlook and advice for action that ensures no delays in dissemination of early warning and a minimum flood early warning lead-time in concerned areas;
- d. Verify if impact outlook messages and early warnings advice for action is widely received, understood and the advice for action in being well considered by recipients at the community level. Identify obstacles for taking the correct action;
- e. Optimizes early warning dissemination and messaging through coordination with PDMAs/DDMAs and explores existing arrangements for early warning dissemination arrangements;
- f. Developed and distributed video documents on flash flood risk in Khyber Pakhtunkhwa (DP) and desired community response to minimize risk.

# Useful References

## *Pakistan*

- National Disaster Management Plan. NDMA. 2012. <http://ndma.gov.pk/plans.php>
- National Disaster Response Plan (NDRP). NDMA. 2010. <http://ndma.gov.pk/plans.php>

## *Regional Guidelines*

### *ASEAN*

- Standard Operating Procedure For Regional Standby Arrangements And Coordination Of Joint Disaster Relief And Emergency Response Operations (SASOP)[http://www.asean.org/storage/images/2015/January/asean\\_resource\\_kit/SASOP.pdf](http://www.asean.org/storage/images/2015/January/asean_resource_kit/SASOP.pdf)
- ASEAN Coordinating Centre For Humanitarian Assistance On Disaster Management (AHA Centre <http://ahacentre.org/content/history>)
- ASEAN Agreement On Disaster Management And Emergency Response (AADMER) [http://ahacentre.org/sites/default/files/default-file\\_admeer-pOhDYAT20GEH11dy.pdf](http://ahacentre.org/sites/default/files/default-file_admeer-pOhDYAT20GEH11dy.pdf)
- Asia-Pacific Economic Cooperation (APEC) – Emergency Preparedness Working Group (EPWG)
- Emergency Response Travel Facilitation for Personnel, Goods and Equipment in Times of Crisis). 2013. [http://publications.apec.org/publication-detail.php?pub\\_id=1468](http://publications.apec.org/publication-detail.php?pub_id=1468)
- APEC Strategy for Disaster Risk Reduction and Emergency Preparedness and Response in the Asia-Pacific Region: 2009-2015, Lima Peru, 2008 [http://mddb.apec.org/documents/2008/TFEP/TFEP1/08\\_tfep1\\_012.pdf](http://mddb.apec.org/documents/2008/TFEP/TFEP1/08_tfep1_012.pdf)

### *East Asia Summit (EAS) – EAS Toolkit*

- EAS Preliminaries: An Overview of the East Asia Summit Disaster Response Toolkit. [http://www.asean.org/wp-content/uploads/images/2015/June/EAS\\_toolkit/EAS-Toolkit-Preliminaries.pdf](http://www.asean.org/wp-content/uploads/images/2015/June/EAS_toolkit/EAS-Toolkit-Preliminaries.pdf)
- EAS Guidance for Rapid Response. [http://www.asean.org/wp-content/uploads/images/2015/June/EAS\\_toolkit/EAS-Toolkit-2.pdf](http://www.asean.org/wp-content/uploads/images/2015/June/EAS_toolkit/EAS-Toolkit-2.pdf)
- EAS National Focal Point. [http://www.asean.org/wp-content/uploads/images/2015/June/EAS\\_toolkit/EAS-Toolkit-1.pdf](http://www.asean.org/wp-content/uploads/images/2015/June/EAS_toolkit/EAS-Toolkit-1.pdf)
- EAS Country Disaster Response Arrangements. [http://www.asean.org/wp-content/uploads/images/2015/June/EAS\\_toolkit/EAS-Toolkit-3.pdf](http://www.asean.org/wp-content/uploads/images/2015/June/EAS_toolkit/EAS-Toolkit-3.pdf)

### *United Nations Guidelines*

- UNDAC Handbook. 2006. <https://docs.unocha.org/sites/dms/Documents/UNDAC%20handbook%20-%20English.pdf>
- UNOCHA. Disaster Response in Asia and the Pacific – A Guide to International Tools and Services. <https://docs.unocha.org/sites/dms/ROAP/Promotional%20Materials/The%20Guide-Web-FINAL.pdf>
- UNOCHA Guidelines on the Use of Foreign Military and Civil-Defence Assets in Disaster Relief

(Oslo Guidelines). 2007. [https://docs.unocha.org/sites/dms/Documents/Oslo%20Guidelines%20ENGLISH%20\(November%202007\).pdf](https://docs.unocha.org/sites/dms/Documents/Oslo%20Guidelines%20ENGLISH%20(November%202007).pdf)

- UNOCHA Foreign Military and Civil Defence Assets in Support of Humanitarian Emergency Operations: What is Last Resort? 2012. <https://docs.unocha.org/sites/dms/Documents/Last%20Resort%20Pamphlet%20-%20FINAL%20April%202012.pdf>
- UNOCHA and IASC. Civil-Military Guidelines and Reference for Complex Emergencies (2008). <https://docs.unocha.org/sites/dms/Documents/CivilMilitary%20Guidelines%20and%20Reference,UN-IASC,%2021%20Oct%2008,English.pdf>
- UNOCHA. APC-MADRO. Asia-Pacific Regional Guidelines for the Use of Foreign Military Assets in Natural Disaster Response Operations. [https://docs.unocha.org/sites/dms/ROAP/Civil%20Military%20Coordination/docs/20140929\\_APC\\_MADRO.pdf](https://docs.unocha.org/sites/dms/ROAP/Civil%20Military%20Coordination/docs/20140929_APC_MADRO.pdf)
- UN-CMCoord Field Handbook [https://docs.unocha.org/sites/dms/ROAP/Civil%20Military%20Coordination/docs/CMCoord%20Field%20Handbook%20v1.0%20\(1\).pdf](https://docs.unocha.org/sites/dms/ROAP/Civil%20Military%20Coordination/docs/CMCoord%20Field%20Handbook%20v1.0%20(1).pdf)
- United Nations. Model Agreement on Customs Facilitation in Humanitarian Assistance. [http://www.wcoomd.org/en/topics/facilitation/activities-and-programmes/~/\\_media/WCO/Public/Global/PDF/Topics/Facilitation/Activities%20and%20Programmes/Natural%20Disaster/United%20Nation%20Model%20of%20Agreement.ashx](http://www.wcoomd.org/en/topics/facilitation/activities-and-programmes/~/_media/WCO/Public/Global/PDF/Topics/Facilitation/Activities%20and%20Programmes/Natural%20Disaster/United%20Nation%20Model%20of%20Agreement.ashx)
- International Search and Rescue Advisory Group (INSARAG) INSARAG Overview. <http://www.unocha.org/what-we-do/coordination-tools/insarag/overview>
- On-Site Operations Coordination Centre (OSOCC). OSOCC Guidelines. 2014. [https://docs.unocha.org/sites/dms/Documents/2014%20OSOCC%20Guidelines\\_FINAL.pdf](https://docs.unocha.org/sites/dms/Documents/2014%20OSOCC%20Guidelines_FINAL.pdf)
- Reception and Departure Centre (RDC). Reception Departure Centre (RDC) Overview. <http://www.unocha.org/what-we-do/coordination-tools/osocc-rdc/overview>

### ***Inter-Agency Standing Committee (IASC)***

- IASC. Alert, Early Warning, and Readiness Report. 2015. [https://interagencystandingcommittee.org/system/files/2015.10.22\\_-\\_iasc\\_alert\\_early\\_warning\\_and\\_readiness\\_report.pdf](https://interagencystandingcommittee.org/system/files/2015.10.22_-_iasc_alert_early_warning_and_readiness_report.pdf)
- Consolidated Appeals Process (CAP)
- <https://interagencystandingcommittee.org/consolidated-appeals-process-cap>
- IASC. Operational Guidelines on the Protection of Persons in Situations of Natural Disasters. 2011
- [http://www.ohchr.org/Documents/Issues/IDPersons/OperationalGuidelines\\_IDP.pdf](http://www.ohchr.org/Documents/Issues/IDPersons/OperationalGuidelines_IDP.pdf)
- IASC. Reference Module for Cluster Coordination at Country Level. 2011
- [https://interagencystandingcommittee.org/system/files/cluster\\_coordination\\_reference\\_module\\_2015\\_final.pdf](https://interagencystandingcommittee.org/system/files/cluster_coordination_reference_module_2015_final.pdf)

### ***World Health Organisation (WHO)***

- Classification and Minimum Standards for Foreign Medical Teams in Sudden Onset Disasters [http://www.who.int/hac/global\\_health\\_cluster/fmt\\_guidelines\\_september2013.pdf?ua=1](http://www.who.int/hac/global_health_cluster/fmt_guidelines_september2013.pdf?ua=1)
- International Health Regulations. 2005 [http://apps.who.int/iris/bitstream/10665/43883/1/9789241580410\\_eng.pdf](http://apps.who.int/iris/bitstream/10665/43883/1/9789241580410_eng.pdf)
- WHO-PAHO Guidelines for the Use of Foreign Field Hospitals in the Aftermath of Sudden-Impact Disasters. 2003 <http://www.who.int/hac/techguidance/pht/FieldHospitalsFolletto.pdf>

- Emergency Response Framework (ERF). [http://www.who.int/hac/about/erf\\_.pdf](http://www.who.int/hac/about/erf_.pdf)

### ***Red Cross and Red Crescent Movement***

- Principles and Rules for Red Cross and Red Crescent Humanitarian Assistance.
- <http://www.ifrc.org/Global/Documents/Secretariat/Accountability/Principles%20Rules%20for%20Red%20Cross%20Red%20Crescent%20Humanitarian%20Assistance.pdf>
- IFRC Disaster Relief Emergency Fund (DREF).
- <http://www.ifrc.org/en/what-we-do/disaster-management/responding/disaster-response-system/financial-instruments/disaster-relief-emergency-fund-dref/>
- International Humanitarian Law. [https://www.icrc.org/eng/assets/files/other/what\\_is\\_ihl.pdf](https://www.icrc.org/eng/assets/files/other/what_is_ihl.pdf)
- <https://www.icrc.org/en/war-and-law>

### ***Civil-Military Coordination***

- <https://docs.unocha.org/sites/dms/Documents/CivilMilitary%20Guidelines%20and%20Reference,UN-IASC,%2021%20Oct%2008,English.pdf>
- UNOCHA. APC-MADRO. Asia-Pacific Regional Guidelines for the Use of Foreign Military Assets in Natural Disaster Response Operations.
- [https://docs.unocha.org/sites/dms/ROAP/Civil%20Military%20Coordination/docs/20140929\\_APC\\_MADRO.pdf](https://docs.unocha.org/sites/dms/ROAP/Civil%20Military%20Coordination/docs/20140929_APC_MADRO.pdf)
- UN-CMCoord Field Handbook
- [https://docs.unocha.org/sites/dms/ROAP/Civil%20Military%20Coordination/docs/CMCoord%20Field%20Handbook%20v1.0%20\(1\).pdf](https://docs.unocha.org/sites/dms/ROAP/Civil%20Military%20Coordination/docs/CMCoord%20Field%20Handbook%20v1.0%20(1).pdf)
- Australian Civil-Military Centre (ACMC). Same Space – Different Mandates (International Edition)
- [https://www.acmc.gov.au/wp-content/uploads/2015/05/ACMC\\_Same-Space\\_Different\\_Mandates\\_International.pdf](https://www.acmc.gov.au/wp-content/uploads/2015/05/ACMC_Same-Space_Different_Mandates_International.pdf)

### ***Humanitarian Principles***

- Core Humanitarian Standard on Quality and Accountability (CHS). <https://corehumanitarianstandard.org/files/files/Core%20Humanitarian%20Standard%20-%20English.pdf>
- Sphere Handbook, Humanitarian Charter and Minimum Standards in Humanitarian Response. 2011.
- <http://www.spherehandbook.org/>
- The 2010 HAP Standard in Accountability and Quality Management (HAP)
- <http://www.chsalliance.org/files/files/Resources/Standards/2010-hap-standard-in-accountability.pdf>
- Minimum Standards for Child Protection in Humanitarian Action <http://cpwg.net/wp-content/uploads/sites/2/2014/03/CP-Minimum-Standards-English-2013.pdf>

### ***World Customs Organization (WCO)***

- Relevant Key Principles of the SAFE Framework of Standards in Further Facilitating the Process

of Clearing Relief Consignments [http://www.wcoomd.org/en/topics/facilitation/activities-and-programmes/~media/WCO/Public/Global/PDF/Topics/Facilitation/Activities%20and%20Programmes/Natural%20Disaster/The%20key%20principles%20of%20the%20SAFE%20Framework\\_V01\\_En.ashx](http://www.wcoomd.org/en/topics/facilitation/activities-and-programmes/~media/WCO/Public/Global/PDF/Topics/Facilitation/Activities%20and%20Programmes/Natural%20Disaster/The%20key%20principles%20of%20the%20SAFE%20Framework_V01_En.ashx)

- Convention on Temporary Admission (Istanbul, 1990) [http://www.wcoomd.org/en/topics/facilitation/activities-and-d%20Agreements/Istanbul/Istanbul\\_legal\\_text\\_Eng.ashx](http://www.wcoomd.org/en/topics/facilitation/activities-and-d%20Agreements/Istanbul/Istanbul_legal_text_Eng.ashx)
- Resolution of the Customs Cooperation Council on the Role of Customs in Natural Disaster Relief. 2011 [http://www.wcoomd.org/en/topics/facilitation/activities-and-programmes/~media/WCO/Public/Global/PDF/About%20us/Legal%20Instruments/Resolutions/Resolution\\_E.ashx](http://www.wcoomd.org/en/topics/facilitation/activities-and-programmes/~media/WCO/Public/Global/PDF/About%20us/Legal%20Instruments/Resolutions/Resolution_E.ashx)



